



11th Edition

Fluoropolymer Hose, Tubing and Assemblies



THE JACKSON ADVANTAGE

We offer engineered solutions that address vibration, thermal, or pressure-related problems as well as applications involving the transfer of liquids or gases. The hose and fittings included in this catalog are precisely manufactured and coupled to assure unequaled quality and immediate response to your needs.

Rapid quotation and delivery response to even the most difficult applications are our specialties. We stock and supply standard medium pressure, ultra high pressure, convoluted, smooth-bore, rubber-covered, and large bore fluoropolymer hoses with their associated fittings, adapters, and accessories.

This catalog includes our full product line of chemical transfer and smooth bore hoses as well as associated products.

THE FLUOROPOLYMER ADVANTAGE

Chemical Resistance - Inert to practically all commercial chemicals, acids, alcohols, coolants, elastomers, petroleum compounds, solvents, vinyls, synthetic lubricants, & hydraulic fluids.

Flex & Shock Resistance - Not affected by continuous flexing, vibration, or impulse - withstands alternating cold and heat cycling.

High Flow Rates - Low coefficient of friction with anti-stick properties insures continuous lower pressure drop during service with a good pressure rating and full vacuum.

Light Weight - Easier to move, handle, and install than rubber hose with a comparable burst pressure rating - ideal as pigtail in gas handling and pneumatic systems where dew point must be low.

Non-Adhesive - Handles substances such as adhesives, asphalt, dyes, grease, glue, latex, lacquers, and paints - no carbon build up when used as a compressor discharge line.

Non-Contaminating - Will not contaminate material, fluid, or gas, non-conductive PTFE is FDA approved for food handling and pharmaceutical applications.

Resists Deterioration - Impervious to weather and can be stored for long periods without aging - will not age during service.

Steam Compatibility - Absorbs no moisture - rated for steam to 250 psi (406°F) - has low volumetric expansion characteristics - easy to clean and sterilize.

TABLE OF CONTENTS

Medium Pressure Smooth Bore Hose of PTFE (SB Series Hose)	3
MasterCrimp Fittings for Smooth Bore Hose.....	4-6
Adapters	7
Ultra High Pressure PTFE Hose (Dense-Pac Hose)	8
High Pressure PTFE Hose (58 Series Hose)	9
Ultra Extra High Pressure Fluoropolymer Hose	10
Rubber Covered FEP/PFA Hose (Jack-Chem Hose)	11
Convoluted Hose with Multiple Layers of PTFE (WCV/BCV Series)	12
Open Pitch Extruded Convoluted PTFE Hose (WCO/BCO Series)	13
Convoluted & Jack-Chem Fittings.....	14-15
Heavy Wall Hose of Convoluted PTFE TUBE with Flared Tube (Jack-Flex Hose)	16
Metal Hose with Smooth Bore of FEP (MTLC Hose)	17
Protective Hose Coverings.....	18
Temperature Derating	19
Chemical Resistance Data & Temperature/Operating Pressure	20-22 (PTFE=Polytetrafluoro-ethylene).



815 Forestwood Drive
Romeoville, Illinois 60446
Website: www.titflex.com
Email: stfr.sales@ushose.net

US Hose • 800/473-0474 • FAX: 815/886-4550

Medium Pressure Smooth Bore Hose of PTFE SB Series • SB-SERIES

Construction

The Jackson smooth bore hose is constructed of an extruded inner-core of virgin PTFE or carbon black static dissipative PTFE with type 304 stainless steel wire braid reinforcement. The braid acts as a pressure carrier and protective covering. Jackson smooth bore hose is found in many of the toughest service applications, handling “problem” fluids such as acids, solvents, fuels, and chemicals of all types. Available with thin or heavy wall tubing of PTFE (polytetrafluoro-ethylene).

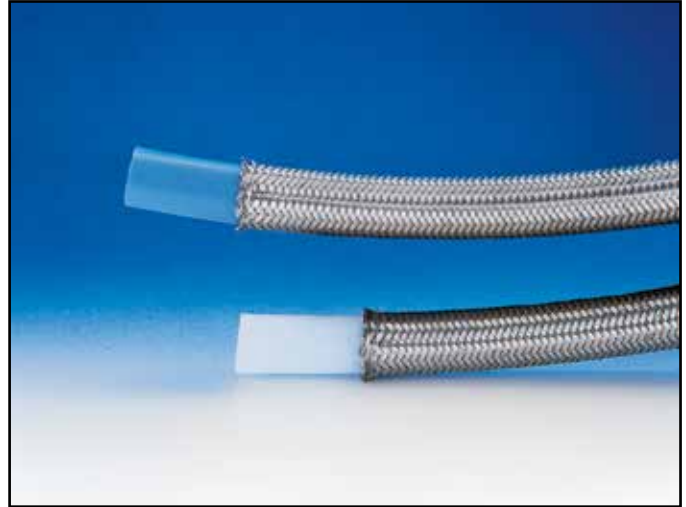

Applications

- Chemical and Acid Transfer
- Pharmaceuticals
- Food Products
- Steam Lines/Tire Presses
- High Temperature Hydraulic/
Air Applications
- Pulp and Paper
- Fuel and Lubricant
- Glass Manufacturing
- Waste Water or Slurry

Benefits

- High working and burst pressures.
- Most economical of all hoses lined with PTFE.
- The low-friction surface of smooth bore hose provides for high flow rates.
- Easily drained and/or cleaned.
- Temperature Rating: -65° F (-54°C) to +450°F (+230°C)

STANDARDS:

- Meets or exceeds requirements of SAE 100R14
- PTFE meets FDA 21 CFR 177.1550

Part Number		Nominal ID	Actual Size		Maximum Working Pressure	Minimum Burst Pressure	Minimum Bend Radius	Approximate Weight/Ft.
White	Black		ID	OD				
S-3 TW	S-3TW BLK	3/16"	.125"	.23"	3000 PSI	12000 PSI	2.0"	.050 lbs.
S-4 TW	S-4TW BLK	1/4"	.19"	.30"	3000 PSI	12000 PSI	2.0"	.060 lbs.
S-5 TW	S-5TW BLK	5/16"	.25"	.37"	3000 PSI	12000 PSI	2.3"	.070 lbs.
S-5Z		5/16"	.24"	.45"	4350 PSI	17400 PSI	2.5"	.100 lbs.
S-6 TW	S-6TW BLK	3/8"	.32"	.40"	2500 PSI	10000 PSI	3.9"	.090 lbs.
S-7 TW		3/8"	.37"	.50"	2250 PSI	9000 PSI	4.5"	.105 lbs.
S-8 TW	S-8TW BLK	1/2"	.41"	.52"	2000 PSI	8000 PSI	4.7"	.115 lbs.
S-10 TW	S-10TW BLK	5/8"	.50"	.59"	1500 PSI	6000 PSI	5.3"	.150 lbs.
S-12 TW	S-12TW BLK	3/4"	.62"	.80"	1200 PSI	4800 PSI	6.5"	.225 lbs.
S-14 TW		3/4"	.77"	.89"	1100 PSI	4400 PSI	7.4"	.225 lbs.
S-16 TW	S-16TW BLK	1"	.87"	1.05"	1000 PSI	4000 PSI	7.8"	.285 lbs.
S-16Z		1"	.87"	1.11"	1250 PSI	5000 PSI	9.0"	.576 lbs.
S-18 TW		1"	1.00"	1.18"	900 PSI	3600 PSI	9.8"	.335 lbs.
S-20Z		1-1/4"	1.13"	1.38"	1000 PSI	4000 PSI	11.0"	.585 lbs.

*Heavy wall available.

MasterCrimp Smooth Bore Fittings

US Hose manufactures and inventories over 500 sizes and styles of fittings. Fitting materials consist of carbon steel, stainless steel, brass, or a combination of materials.

We will manufacture custom fittings to your specifications. Contact our customer service department for more information about this service.

PERMANENT CRIMP FITTINGS

Male Pipe Brass



Male Pipe Stainless



Male Pipe Carbon



Male Pipe Fittings - Brass	
Part No.	Description-Hose Size
0304TW	MNPT (1/8-27) - 4
0504TW	MNPT (1/4-18) - 4
0505TW	MNPT (1/4-18) - 5
0306TW	MNPT (1/4-18) - 6
0506TW	MNPT (3/8-18) - 6
0308TW	MNPT (3/8-18) - 8
0508TW	MNPT (1/2-14) - 8
0510TW	MNPT (1/2-14) - 10
0512TW	MNPT (3/4-14) - 12
0516TW	MNPT (1-11.5) - 16
0516Z	MNPT (1-11.5) - 16Z

Male Pipe Fittings - 303 Stainless	
Part No.	Description-Hose Size
1704TW	MNPT (1/8-27) - 4
2004TW	MNPT (1/4-18) - 4
2005TW	MNPT (1/4-18) - 5
1706TW	MNPT (1/4-18) - 6
2006TW	MNPT (3/8-18) - 6
1708TW	MNPT (3/8-18) - 8
2008TW	MNPT (1/2-14) - 8
2010TW	MNPT (1/2-14) - 10
2012TW	MNPT (3/4-14) - 12
2016TW	MNPT (1-11.5) - 16
2016Z	MNPT (1-11.5) - 16Z
2020Z	MNPT (1 1/4-11.5) - 20Z

Male Pipe Fittings - Carbon Steel	
Part No.	Description-Hose Size
0904TW	MNPT (1/8-27) - 4
1004TW	MNPT (1/4-18) - 4
1005TW	MNPT (1/4-18) - 5
0905TW	MNPT (1/8-27) - 5
0906TW	MNPT (1/4-18) - 6
1006TW	MNPT (3/8-18) - 6
0908TW	MNPT (3/8-18) - 8
1008TW	MNPT (1/2-14) - 8
1010TW	MNPT (1/2-14) - 10
1012TW	MNPT (3/4-14) - 12
1016TW	MNPT (1-11.5) - 16
1016Z	MNPT (1-11.5) - 16Z
1020Z	MNPT (1 1/4-11.5) - 20Z

316 Stainless Steel also available

Female Swivel Brass



Female Swivel Stainless



Female Swivel Carbon



JIC 37° / SAE 45° Female Swivel Fittings	
Part No.	Description-Hose Size
3504TW	JIC/SAE SWIVEL (7/16-20) - 4
3505TW	JIC/SAE SWIVEL (1/2-20) - 5
3506TW	JIC (9/16-18) - 6
3606TW	SAE SWIVEL (5/8-18) - 6
3508TW	JIC/SAE SWIVEL (3/4-16) - 8
3510TW	JIC/SAE SWIVEL (7/8-14) - 10
3512TW	JIC (1 1/16-12) - 12
3612TW	SAE SWIVEL (1 1/16-14) - 12
3516TW	JIC (15/16-12) - 16
3516Z	JIC (1 5/16-12) - 16Z

JIC Swivel Fittings - 303 Stainless	
Part No.	Description-Hose Size
4003TW	37 JIC SWIVEL (3/8-24) - 3
4303TW	37 JIC SWIVEL (7/16-20) - 3
4004TW	37 JIC/SAE SWIVEL (7/16-20) - 4
3905TW	37 JIC SWIVEL (7/16-20) - 5
4005TW	37 JIC SWIVEL (1/2-20) - 5
4006TW	37 JIC SWIVEL (9/16-18) - 6
4008TW	37 JIC/SAE SWIVEL (3/4-16) - 8
4010TW	37 JIC/SAE SWIVEL (7/8-14) - 10
4012TW	37 JIC SWIVEL (1 1/16-12) - 12
4016TW	37 JIC SWIVEL (1 5/16-12) - 16
4016Z	37 JIC SWIVEL (1 5/16-12) - 16Z
4020Z	37 JIC SWIVEL (1 5/8-12) - 20Z

JIC Swivel Fittings - Carbon Steel	
Part No.	Description-Hose Size
3004TW	37 JIC/SAE SWIVEL (7/16-20) - 4
2905TW	37 JIC SWIVEL (7/16-20) - 5
3005TW	37 JIC/SAE SWIVEL (1/2-20) - 5
3006TW	37 JIC SWIVEL (9/16-18) - 6
3007TW	37 JIC SWIVEL (9/16-18) - 7N
3008TW	37 JIC/SAE SWIVEL (3/4-16) - 8
3010TW	37 JIC/SAE SWIVEL (7/8-14) - 10
3012TW	37 JIC SWIVEL (1 1/16-12) - 12
3016TW	37 JIC SWIVEL (1 5/16-12) - 16
3016Z	37 JIC SWIVEL (1 5/16-12) - 16Z
3020Z	37 JIC SWIVEL (1 5/8-12) - 20Z

MasterCrimp Smooth Bore Fittings

SANITARY TABLE

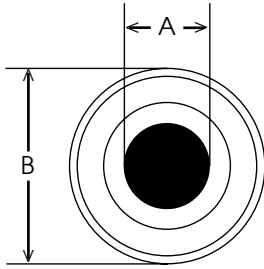

MINI SANITARIES

Size	A	B
1/2"	0.375	0.984
3/4"	0.625	0.984

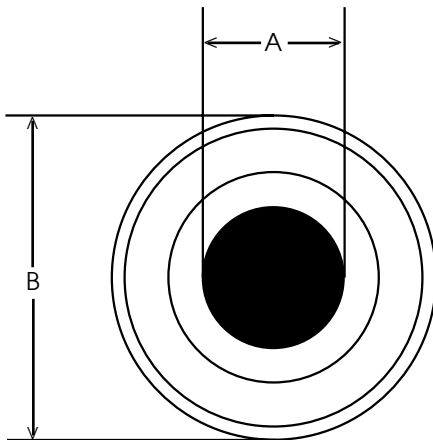

STANDARD SANITARIES

Size	A	B	Bore Thru
1/2"	0.875	1.984	0.375
3/4"	0.875	1.984	0.609
1"	0.875	1.984	0.844
1 1/2"	1.375	1.984	1.312
2"	1.870	2.5	1.75
3"	2.875	3.576	2.73

A = OPENING ID • B = FACE OD

SANITARY FITTINGS

Mini Sanitary



Available Materials:
316 Stainless Steel

Sanitary



Available Materials:
316 Stainless Steel

CRIMP FITTINGS FOR SMOOTH BORE HOSE

MasterCrimp Assembly System

Fabricating Smooth Bore PTFE Hose Assemblies Is Now Fast, Easy & Reliable

- Complete fitting alloy selection in stock and ready for fast delivery:
- Carbon Steel - - Brass - - Stainless Steel -
- **MasterCrimp saves on your inventory costs** by offering you a single fitting that will fit both thin and heavy wall smooth bore hose.
- Simple assembly process **minimizes tooling & labor costs.**

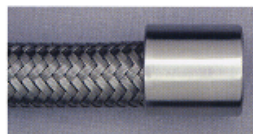

After hose is cut to length, MasterCrimp ferrules are designed to slide on either by hand or with an optional collar assembly tool. One size collar fits both thin and heavy wall hose.

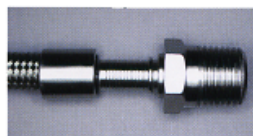

Easy insertion of the barbed hose end by hand. No time is wasted with finding and loading fittings in tool fixtures.

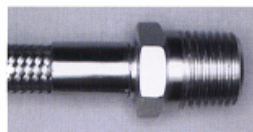

Straight crimp on the entire length of the ferrule. Jackson MasterCrimp fittings have a clean, smooth look that is appealing to all types of customers.

MasterCrimp Smooth Bore Fittings

SPECIAL APPLICATION FITTINGS

Brass Female Pipe



Hose Size	Part No.	Pipe Thread
-5	0405TW	1/4" - 18

Stainless Female Pipe



Hose Size	Part No.	Pipe Thread
-5	2405TW	1/4" - 18



Description	Hose Size	Part No.	Thread Size
Power Trim 45°	-4	PT-45-4	3/8-24
Power Trim 90°	-4	PT-90-4	3/8-24
Power Trim Straight	-4	PT-S-4	3/8-24
Paint Spray Swivel	-5	1505TW	1/4" NPS

Power Trim fittings are available in 304 Stainless Steel. Paint Spray Swivel available in Carbon Steel.



Tube End Fittings - 316 Stainless	
Part No.	Description-Hose Size
4804TW	1/4" OD Tube End - 4
4806TW	3/8" OD Tube End - 6
4808TW	1/2" OD Tube End - 8
4812TW	3/4" OD Tube End - 12

JACKSON SMOOTH BORE ASSEMBLIES







Our modern production cell for smooth bore assemblies provides fast turnaround and offers tremendous value to our customers business by eliminating the need for users to stock bulk products. Jackson inventories are purposely maintained at high levels so that we can respond in a short time to your installation requirements.

Depending on the application your assemblies can be tested with water or nitrogen gas with a complete certificate of test. Our in house services also include cleaning, tagging and bagging required for high purity transfer conditions.

37° JIC to NPT PIPE THREAD ADAPTERS

Adapters are available in brass, carbon steel, and 300 Series Stainless Steel.
Additional adapters are available - consult the factory for details.

							
Pipe Thread	JIC Straight Thread	JIC Dash Size	Male Adapter Part#	Male 90 Elbow Part #	Male 45 Elbow Part #	Female Adapter Part #	Female 90 Elbow Part #
1/8-27	3/8-24	3	1003-1	9003-1	4503-1	1003-1F	9003-1F
1/8-27	7/16-20	4	1004-1	9004-1	4504-1	1004-1F	9004-1F
1/4-18	7/16-20	4	1004-2	9004-2	4504-2	1004-2F	9004-2F
3/8-18	7/16-20	4	1004-3	9004-3	4504-3	1004-3F	9004-3F
1/8-27	1/2-20	5	1005-1	9005-1	4505-1	1005-1F	9005-1F
1/4-18	1/2-20	5	1005	9005	4505	1005-F	9005-F
3/8-18	1/2-20	5	1005-2	9005-2	4505-2	1005-2F	9005-2F
1/4-18	9/16-18	6	1006-1	9006-1	4506-1	1006-1F	9006-1F
3/8-18	9/16-18	6	1006-2	9006-2	4506-2	1006-2F	9006-2F
1/2-14	9/16-18	6	1006-3	9006-3	4506-3	1006-3F	9006-3F
1/4-18	3/4-16	8	1008	9008	4508	1008-F	9008-F
3/8-18	3/4-16	8	1008-1	9008-1	4508-1	1008-1F	9008-1F
1/2-14	3/4-16	8	1008-2	9008-2	4508-2	1008-2F	9008-2F
3/4-14	3/4-16	8	1008-3	9008-3	4508-3	1008-3F	9008-3F
3/8-18	7/8-14	10	1010-1	9010-1	4510-1	1010-1F	9010-1F
1/2-14	7/8-14	10	1010	9010	4510	1010-F	9010-F
3/4-14	7/8-14	10	1010-2	9010-2	4510-2	1010-2F	9010-2F
1/2-14	1-1/16 - 12	12	1012-1	9012-1	4512-1	1012-1F	9012-1F
3/4-14	1-1/16 - 12	12	1012	9012	4512	1012-F	9012-F
1-11-1/2	1-1/16 - 12	12	1012-2	9012-2	4512-2	1012-2F	9012-2F
3/4-14	1-5/16 - 12	16	1016-1	9016-1	4516-1	1016-1F	9016-1F
1 - 11-1/2	1-5/16 - 12	16	1016	9016	4516	1016-F	9016-F
1-1/4 - 11-1/2	1-5/16 - 12	16	1016-2	9016-2	4516-2	1016-2F	9016-2F
1 - 11-1/2	1-5/8 - 12	20	1020-1	9020-1	4520-1	1020-1F	9020-1F
1-1/4 - 11-1/2	1-5/8 - 12	20	1020	9020	4520	1020-F	9020-F
1-1/2 - 11-1/2	1-5/8 - 12	20	1020-2	9020-2	4520-2	1020-2F	9020-2F
1-1/2 - 11-1/2	1-7/8 - 12	24	1024	9024	4524	1024-F	9024-F
2 - 11-1/2	2-1/2 - 12	32	1032	9032	4532	1032-F	9032-F

Prefix Part Number "B" for Brass, "C" for Carbon Steel, and "S" for 300 Series Stainless Steel.
Please consult the factory for additional sizes, shapes, and materials.

DENSE-PAC HOSE • Ultra High Pressure Hose PTFE



Construction

The Jackson Dense-Pac (1000 Series) hose is constructed of an inner core of carbon black static dissipative PTFE. A multitude of stainless steel wires are braided together, forming a single braid of protection. In larger sizes (-12 through -24), an additional layer of braid is added between the PTFE inner core and the outer braid. The post-sintered tube increases its density, reducing effusion in pneumatic applications. For liquid and hydraulic applications, a non-sintered PTFE tube provides lower costs without sacrificing performance. (DPN Series)

Fittings: Jackson's Dense-Pac comes standard with 300 series stainless steel JIC 37° female swivels. Jackson offers a wide selection of other styles for OEM and compressed gas applications.

Applications Benefits

- | | |
|---|--|
| <ul style="list-style-type: none"> • High Temperature Hydraulics – Steel Mills • High Pressure Chemical Transfer • Two Part Reaction Injection Molding • Hot Melt Glue (Boxes & Packaging) • High Pressure Gas (Pigtail) • Life Support System • Oil Field Applications • High Temperature Heated Hose Applications • Urethane Transfer Applications | <ul style="list-style-type: none"> • Extreme high pressure hose. • Smooth bore improves flow rates. • Resists kinking in service. • High durability and unlimited shelf life. • Sizes up to 1-1/2" I.D. • Lightweight with tight bend radius. • Temperature Rating: -65°F (-54°C) to +400°F (+204°C). |
|---|--|

Please notify the factory if this hose will be used in a moisture-sensitive application.

Part #	Nominal I.D.	Actual Size		Max. Working Pressure*	Test Pressure	Min. Burst Pressure*	High Temp. Burst Pressure	Min. Bend Radius	Approx. Weight Per. Foot
		I.D.	O.D.						
S-4DP	1/4"	.22"	.39"	5000 PSI	10000 PSI	15000 PSI	12000 PSI	1.50"	.10 lbs.
S-6DP	3/8"	.31"	.49"	5000 PSI	10000 PSI	15000 PSI	12000 PSI	2.50"	.16 lbs.
S-8DP	1/2"	.40"	.62"	5000 PSI	10000 PSI	15000 PSI	12000 PSI	2.88"	.23 lbs.
S-10DP	5/8"	.50"	.73"	5000 PSI	10000 PSI	15000 PSI	12000 PSI	3.25"	.32 lbs.
S-12DP	3/4"	.62"	.99"	5000 PSI	10000 PSI	15000 PSI	12000 PSI	3.88"	.66 lbs.
S-16DP	1"	.87"	1.27"	5000 PSI	10000 PSI	15000 PSI	9000 PSI	5.00"	1.02 lbs.
S-20DP	1-1/4"	1.12"	1.66"	5000 PSI	10000 PSI	15000 PSI	9000 PSI	12.00"	1.85 lbs.
S-24DP	1-1/2"	1.38"	1.90"	4000 PSI	8000 PSI	12000 PSI	9000 PSI	14.00"	1.91 lbs.

*Minimum burst pressures calculated at 70°F. *Non-Impulse Applications. For impulse applications, working pressure is 3000 PSI. High temperature pressures calculated at 400°F; working pressure drops to 3000 PSI. Please contact the factory. For gas and breathing air applications specify DP post-sintered hose only.

Ultra High Pressure Hose of PTFE • 58-SERIES

Construction

58 Series hose is constructed of carbon black static dissipative innercore of PTFE with layers of spiral wrap between two layers of braid, which make this hose the premiere in heavy-duty ultra high pressure hose. The post-sintered tube increases its density, reducing effusion in pneumatic applications.

Jackson 58 Series comes standard with type 300 stainless steel JIC swivels. Male or female NPT adapters are available. Solid female and male NPT fittings in 1/4" are also an option.



Applications

- High Temperature Hydraulics
- High Pressure Phosphate Ester Applications
- High Pressure Chemical Transfer
- Two Part Epoxy (RIMM)
- Hot Melt Glue (Boxes & Packaging)
- High Pressure Gas Applications (Pigtail)
- Life Support Systems
- Oil Field Applications
- High Temperature Heated Hose Applications

Benefits

- Extreme high pressure hose.
- Smooth bore improves flow rates.
- Resists kinking in service.
- Unlimited shelf life.
- Suitable for impulse service.
- Temperature Rating: -65°F (-54°C) to +400°F (+204°C)

Part #	Nominal I.D.	Actual Hose Size		Max. Working Pressure	Test Pressure	Min. Burst Pressure*	Min. Bend Radius	Approx. Weight Per. Foot
		I.D.	O.D.					
S-4HP	1/4"	.23"	.50"	6000 PSI	9000 PSI	24000 PSI	3.00"	.24 lbs.
S-6HP	3/8"	.30"	.62"	6000 PSI	9000 PSI	24000 PSI	5.00"	.40 lbs.
S-8HP	1/2"	.40"	.74"	6000 PSI	9000 PSI	24000 PSI	5.75"	.49 lbs.

*Minimum burst pressures calculated at 70°F. For high temperature pressures, please contact the factory.

Ultra Extra High Pressure Fluoropolymer Hose



Basic Design

1. PFA or ETFE Inner Tubing
2. Kevlar Braid
3. Interlayer PTFE Tape
4. Stainless Steel Braid
5. Hytel Jacket

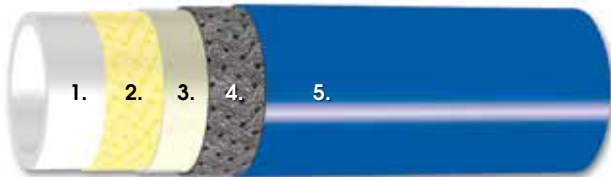

Construction

Ultra Series extra high pressure hose is constructed with fluoropolymer innercores of non conductive ETFE or PFA. Unlike other types of hose that use multiple layers of stainless steel wire reinforcement, Ultra incorporates the use of one braided layer of high tensile aramid fiber and one layer of stainless steel. This value engineered constructions reduces weight and improves bend radius while increasing burst pressure. An integral abrasion resistant Hytel jacket protects the exterior braid and has a smooth finished appearance. Ultra PFA hose has a black Hytel jacket and the Ultra ETFE is differentiated with a **blue** Hytel jacket. For more information on Hytel properties please consult the our home page for the Hytel Technical Bulletin.

Applications

- Compressed Gas Cylinder Filling
- Nitrogen Purging
- Life Support Packs
- Hydraulic Phosphate Ester Transfer
- High Pressure Paint Equipment
- Epoxy/Adhesive Systems
- High Pressure Sanitary Service
- Meets FDA Requirements for food grade compatibility
- PTFE meets FDA 21 CFR 177.1550

Benefits

- Extra Long **Continuous Lengths Up to 150 Feet**
- Low Effusion PFA & ETFE Fluoropolymer Innercore
- Proprietary Jackson Engineered **HRSA** Fitting Design Assures Integrity Of Hose To Fitting Joint
- Internal media Minus 40 F to +200F; not to exceed 180F ambient external temperature
- Fast Turnaround On Custom Made Assemblies
- Each Assembly Fully Pressure Tested (see table below)

Part Number	ID Inch	Nom-inal Size	Working Pressure	Burst Pressure	Hydro-static** Pressure Test	Nitrogen** Pressure Test	OD Inch	Minimum Bend Radius (Inch)	Weight per Ft.
S-4 PFA/ETFE Ultra	0.22	1/4	6,000 PSI	24,000 PSI	9,000 PSI	6,000 PSI	46	1.0	.11 lbs
S-6 PFA/ETFE Ultra	0.31	3/8	6,000 PSI	24,000 PSI	9,000 PSI	6,000 PSI	54	2.0	.33 lbs.
S-8 PFA/ETFE Ultra	0.40	1/2	6,000 PSI	24,000 PSI	9,000 PSI	6,000 PSI	71	2.3	.35 lbs.

- Ultra ETFE for helium and hydrogen gas transfer
- For oxygen gas use Ultra PFA ; Ultra ETFE is not recommended for oxygen service
- For gas applications assemblies are pressure tested with nitrogen at 6000 PSI, for fluid transfer each hose assembly is hydrostatically pressure tested at 9000 PSI.

Construction

Jack-Chem has been custom engineered for lasting service in the most demanding applications. Jack-Chem starts with a smooth; non-stick FDA approved white FEP fluoropolymer, PTFE and PFA liners can be custom ordered. Two plies of synthetic rubber reinforced with horizontal fabric braid are permanently bonded to the FEP tube. A wire helix is included to support the shape in full vacuum service and to prevent kinking. This provides a grounding path for electrical charges through the exterior body of the hose. The entire hose is protected by an abrasion resistant EPDM cover that will not fade or discolor with age and is also weather resistant.



FEP Liner flared over flange retainer face for continuous smooth media contact with FEP liner
*White Fluoropolymers are FDA approved.

Applications

- Chemical Transfer
- Acid Transfer
- Pharmaceutical Manufacturing
- Photo Emulsions
- Food Processing
- Large Diameter Smooth Bore
- Tank Truck
- Slurry/Waste

Benefits

- Smooth Bore up to 2" I.D.
- Less turbulence created by smooth bore provides better flow rates.
- Thermal insulation.
- Easily drained/steam cleanable.
- Feel of a rubber hose versus handling braided wire.
- Rated up to 550 PSI working pressure.
- Temperature Rating: -40°F (-40°C) to +300°F (+148°C). Contact the factory for temps over 300°F.

Part Number White	Nominal Hose Size		Maximum Working Pressure *	Minimum Burst Pressure	Vacuum Rating *	Minimum Bend Radius	Approximate Weight per Ft.
	I.D.	O.D.					
JC-08	0.50"	0.87"	550 PSI	2200 PSI	Full	3.0"	.33 lbs.
JC-12	0.75"	1.25"	450 PSI	1800 PSI	Full	3.5"	.60 lbs.
JC-16	1.00"	1.50"	450 PSI	1800 PSI	Full	4.0"	.73 lbs.
JC-24	1.50"	2.00"	400 PSI	1600 PSI	Full	8.5"	1.20 lbs.
JC-32	2.00"	2.50"	300 PSI	1200 PSI	Full	10.5"	1.45 lbs.
JC-48	3.00"	3.50"	175 PSI	700 PSI	Full	25.0"	2.40 lbs.

* All pressures and vacuum ratings calculated at 70°F.

WCV/BCV SERIES • Convoluted Hose with Multiple Layers of PTFE



Construction

Jackson Industries WCV Series has a white, helical, convoluted inner tubing of multiple layers of PTFE, which is reinforced with PTFE-impregnated fiberglass and a stainless steel braid. The BCV series has a black, carbon filled, conductive inner tubing which serves to dissipate electrostatic charges.

Applications Benefits

- Chemical Transfer
- Acid Transfer
- Tire Mold Equipment
- Purified Water
- Reverse Osmosis Systems
- Fill Lines
- Air Compressors
- Waste Water & Slurry

- Very flexible, requiring very little force to deflect.
- Tightest or smallest bend radius.
- High working pressures.
- Light weight per foot.
- Temperature Rating: -65°F (-54°C) to +400°F (+230°C)

Part Number		Nominal Hose Size		Operating Pressure	Burst Pressure	Bend Radius	Approx. Weight Per Foot
White	Black	I.D.	O.D.				
WCV-08	BCV-08	0.50	0.76	1000	4000	1.00	.16
WCV-10	BCV-10	0.62	0.91	1000	4000	1.50	.22
WCV-12	BCV-12	0.75	1.07	1000	4000	2.00	.29
WCV-16	BCV-16	1.00	1.34	1000	4000	3.00	.41
WCV-20	BCV-20	1.25	1.57	1000	4000	6.25	.50
WCV-24	BCV-24	1.50	1.81	750	3000	7.50	.62
WCV-32	BCV-32	2.00	2.32	500	2000	10.00	.97

All pressures are calculated at 70F; for higher temperatures check de-rating chart. For any applications requiring vacuum conditions please consult factory.

Open Pitch Extruded Convuluted Hose of PTFE • WCO/BCO SERIES

Construction

The WCO series is constructed of **extruded seamless** vacuum-formed white tube of open-pitch convuluted PTFE. The BCO series consists of black conductive tubing for static dissipative purposes. Both are protected by high coverage stainless steel braid. The internal profile of the hose has been formed to support high flow rates and the helical design aids in self draining. All fittings have been specially designed for use on the hose to increase the service life of the assembly.



Applications

- Chemical Transfer
- Acid Transfer
- Thermal cycling or steam applications
- Tire mold equipment
- Steam
- Fill Lines
- Air compressors
- Applications requiring high flexibility
- Tank Truck

Benefits

- Open pitch aids self-draining and cleaning of hose.
- Suitable for thermal cycling or steam applications - will not delaminate.
- Flexible design for easy installation.
- Steam cleanable.
- Light weight per foot.
- Can be autoclaved.
- High pressure ratings.
- Temperature Rating: -65°F (-54°C) to +450°F (+230°C)

Part Number		Nominal Hose Size		Max. Working Pressure	Min. Burst Pressure	Vacuum Rating*	Min. Bend Radius	Approx. Weight Per Foot
White	Black	ID	OD					
WCO-06	BCO-06	0.37"	0.56"	1850 PSI	7400 PSI	28"	2.0"	.23 lbs.
WCO-08	BCO-08	0.50"	0.75"	1500 PSI	6000 PSI	28"	3.0"	.27 lbs.
WCO-12	BCO-12	0.75"	1.01"	1300 PSI	5200 PSI	28"	3.5"	.43 lbs.
WCO-16	BCO-16	1.00"	1.30"	1000 PSI	4000 PSI	28"	4.0"	.63 lbs.
WCO-20	BCO-20	1.25"	1.57"	900 PSI	3600 PSI	28"	4.5"	.75 lbs.
WCO-24	BCO-24	1.50"	1.89"	700 PSI	2800 PSI	28"	4.5"	.88 lbs.
WCO-32	BCO-32	2.00"	2.38"	500 PSI	2000 PSI	28"	5.0"	1.11 lbs.
WCO-48		2.91"	3.8"	100 PSI	400 PSI	None	12.0"	1.75 lbs.

*All pressures and vacuum ratings calculated at 70°F. *Consult factory for vacuum ratings at higher temperatures. For applications involving higher temperatures, please consult the factory.

CONVOLUTED & JACK-CHEM FITTINGS

THREADED FITTINGS

Male Pipe Hex



Part #
10
20

Fitting Material
Carbon Steel
Stainless Steel

Female JIC 37°



Part #
30
40

Fitting Material
Carbon Steel
Stainless Steel

Butt Weld/Victaulic**

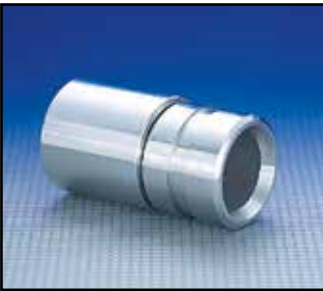

Part #
91

Fitting Material
Stainless Steel

US Hose manufactures and inventories over 500 sizes and styles of fittings. Fitting materials consist of carbon steel, stainless steel, combination, and polypropylene.

We will manufacture custom fittings to your specifications. Contact our customer service department for more information about this service.

*Special Fittings - Please consult the factory for pricing and availability.

**Pipe is standard, tube available. Please specify.

I-LINE FITTINGS

Male I-Line



Part #
98

Fitting Material
Stainless Steel

Female I-Line



Part #
99

Fitting Material
Stainless Steel

SANITARY

Sanitary

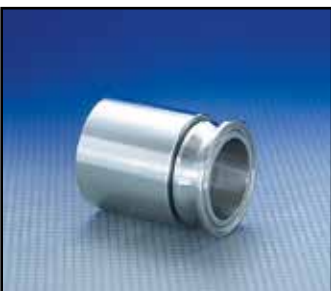

Part #
70

Fitting Material
Stainless Steel

Bevel Seat Sanitary

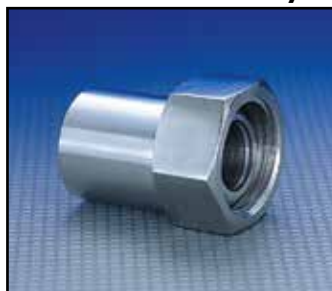

Part #
69

Fitting Material
Stainless Steel

Mini Sanitary

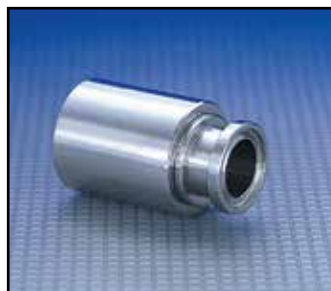

Part #
71

Fitting Material
Stainless Steel

Other sanitary fittings available - contact the factory for additional fitting information.

CONVOLUTED & JACK-CHEM FITTINGS

CAM & GROOVE

Male C & G



Part # 73 **Fitting Material** Stainless Steel

Female Rigid C & G



Part # 83 **Fitting Material** Stainless Steel

Encapsulated C & G



Part # 88 **Fitting Material** Stainless Steel

Encapsulated C & G



Part # 85 **Fitting Material** Stainless Steel

FLANGES

Flange Retainer

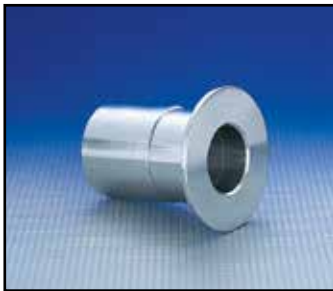

Part # 50 **Fitting Material** Stainless Steel

PFA Encapsulated Flange Retainer

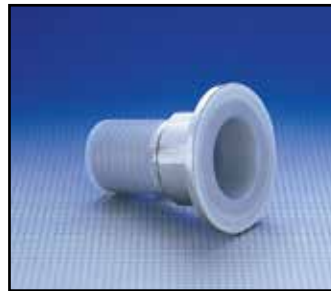

Part # 60 **Fitting Material** Stainless Steel

COMPRESSION

Tube Stub for Instrumentation Fitting*



Part # 48 **Fitting Material** Stainless Steel

*Please consult the factory for pricing & availability.

POLYPROPYLENE FITTINGS

Male Pipe

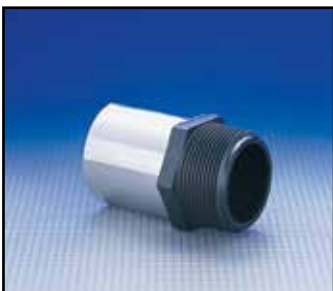

Part # P20 **Fitting Material** Polypropylene
Stainless Steel Collar

Sanitary



Part # P70 **Fitting Material** Polypropylene
Stainless Steel Collar

Female C & G



Part # P83 **Fitting Material** Polypropylene
Stainless Steel Collar

Male C & G



Part # P73 **Fitting Material** Polypropylene
Stainless Steel Collar

Polypropylene fittings have a pressure rating of 120 PSI and temperature rating of up to 180°F.

JACK-FLEX • Heavy Wall Hose of Convuluted PTFE with Flared-Tube



Construction

Jack-Flex is constructed from convoluted, heavy wall, seamless extruded white lined in a stainless steel braid. It offers the latest in hoses lined with PTFE with flared tubing. In this process, the convoluted tubing is passed through the flange retainer, and flared over the face of the flange, effectively isolating the flange from the transfer chemical. Jack-Flex is ideal for situations where internal corrosion of the fitting and contamination of the chemical is not tolerable.

Applications

- Thermal Cycling
- Transfer of almost all chemicals
- Acid Transfer
- Vibration Elimination
- Sanitary Applications
- Short Assembly Specification
- Applications requiring high flexibility

Available as factory-built and tested assemblies only.

Benefits

- Internal corrosion of fittings eliminated.
- No metallic contamination of transfer chemical from fitting.
- Simplified installation - no gaskets required. Seal is made on flare.
- Helical design of hose aids draining and cleaning.
- Suitable for thermal cycling or steam applications - will not delaminate.
- Reduced energy losses through fitting gives higher flow rates.
- Eliminates crevice corrosion from flange insert in hose.
- Temperature Rating: -65° F (-54°C) to +450°F (+230°C)

Part Number White	Nominal Hose Size		Maximum Working Pressure	Minimum Burst Pressure	Minimum Bend Radius
	I.D.	O.D.			
JF-12	0.78"	1.08"	425 PSI	1700 PSI	3.0"
JF-16	0.97"	1.36"	350 PSI	1400 PSI	4.0"
JF-20	1.32"	1.70"	330 PSI	1350 PSI	5.5"
JF-24	1.49"	1.85"	275 PSI	1100 PSI	7.0"
JF-32	1.92"	2.43"	250 PSI	1000 PSI	8.5"
JF-48	2.91"	3.80"	100 PSI	400 PSI	12.0"
JF-64	3.92"	4.95"	100 PSI	400 PSI	18.0"

All pressures calculated at 70°F. For applications involving higher temperatures, please contact the factory. Conductive Black is available on request.

Construction

The construction of an MTLC hose begins with flanged metal hose braided with stainless steel. A smooth inner liner of extruded PTFE is inserted into the hose, locked in place, and flared over the flange faces. This PTFE liner is stationary and will not move within the hose. Vent holes in the ends prevent gas build-up between layers.

Flanges for assemblies on pages 16-17 are available in carbon steel, 304 or 316 stainless steel.



Applications

- Acid Transfer
- Chemical Transfer
- Generally suitable for in-plant applications
- Vibration elimination in piping systems
- Large diameter smooth bore
- Slight misalignment in plastic or lined piping systems

Available as factory-built and tested assemblies only.

Benefits

- PTFE protection against chemical attack throughout the entire assembly length.
- Smooth liner - no entrapment areas.
- High flow rates.
- Easily cleaned.
- Offers ruggedness in service.
- Temperature Rating: -65°F (-54°C) to +350°F (+176°C)

Part Number	Nominal Hose Size		Max. Working Pressure*	Min. Burst Pressure	Vacuum Rating (HG)*	Approx. Weight Per Foot
	I.D.	O.D.				
MTLC-16	1.00"	1.64"	500 PSI	2000 PSI	26"	2.00 lbs.
MTLC-24	1.50"	2.33"	400 PSI	1600 PSI	26"	3.86 lbs.
MTLC-32	2.00"	2.88"	300 PSI	1200 PSI	24"	5.00 lbs.
MTLC-48	3.00"	3.94"	200 PSI	800 PSI	24"	5.25 lbs.
MTLC-64	4.00"	4.98"	150 PSI	600 PSI	20"	5.60 lbs.
MTLC-96	6.00"	7.00"	150 PSI	600 PSI	20"	13.00 lbs.
MTLC-128	8.00"	9.10"	125 PSI	500 PSI	20"	20.00 lbs.
MTLC-160	10.00"	11.20"	100 PSI	400 PSI	20"	26.00 lbs.
MTLC-192	12.00"	13.22"	90 PSI	360 PSI	20"	34.50 lbs.

*All pressures and vacuum ratings calculated at 70°F. **Please consult factory regarding flexibility restrictions**

PROTECTIVE HOSE COVERINGS

Jackson offers several types of protective hose coverings to help extend the service life of our Fluoropolymer hoses.



SPRING GUARD

To prolong the life of hose lines that are exposed to rugged operating conditions, such as severe flexing, Spring Guard reduces kinking and protects the hose from abrasion and rough handling.



SILICONE FIRESLEEVE

This fiberglass sleeving has a coating of silicone rubber bonded to it which offers flame resistance that will protect the hose from extreme temperature conditions.



HEAT SHRINK TUBING

To minimize hose O.D., heat shrinkable tubing is used in applications where cleanliness is essential, such as food and pharmaceutical processing. This provides easy cleaning of the outer hose surface.



ARMOR

A highly flexible heavy duty metal casing to protect the hose against severe handling abuse and overbending. This can be applied over the entire length or in short sections at the end connection.



NYLON

Woven from thousands of nylon filaments into an abrasion-resistant sleeve, the nylon cover extends individual hose life in severe abrasive environments. As it is scuffed and worn, its filaments frizz, forming an even thicker, more protective shield.

Contact Customer Service for more information about protective hose coverings.

TEMPERATURE DERATING

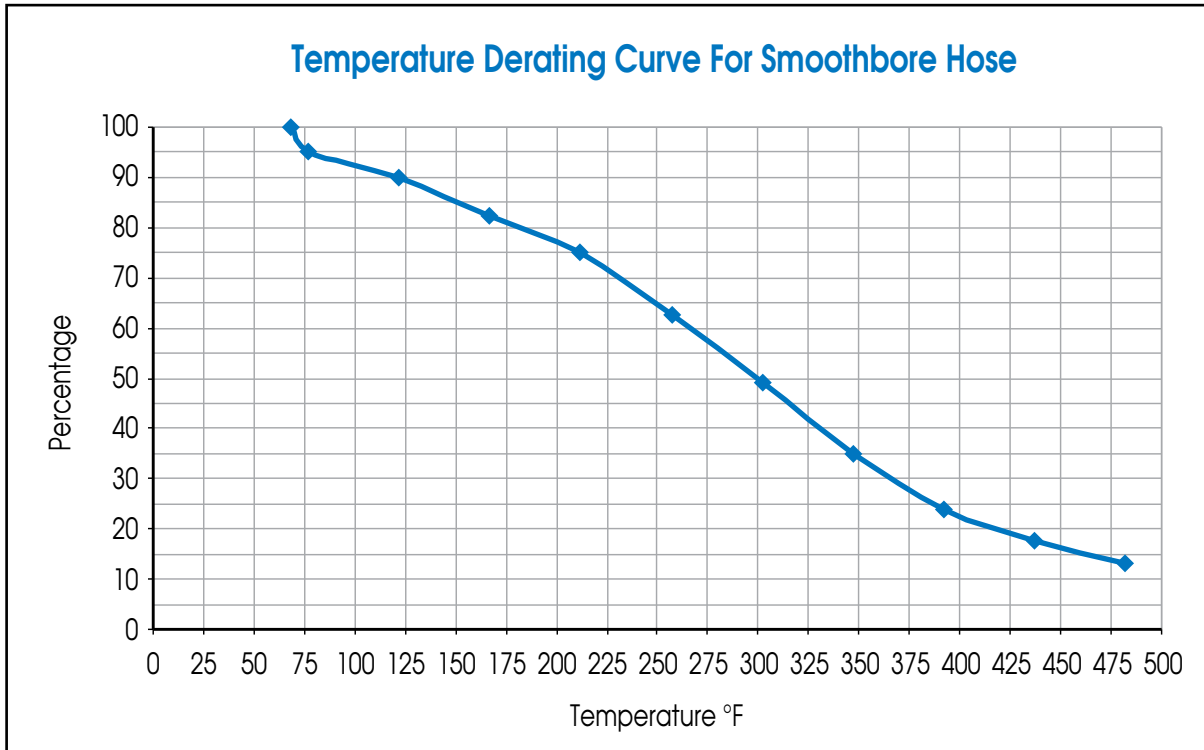

For WCO / BCO Series – Decrease Working Pressure 1% For Every 2°F Above 250°F

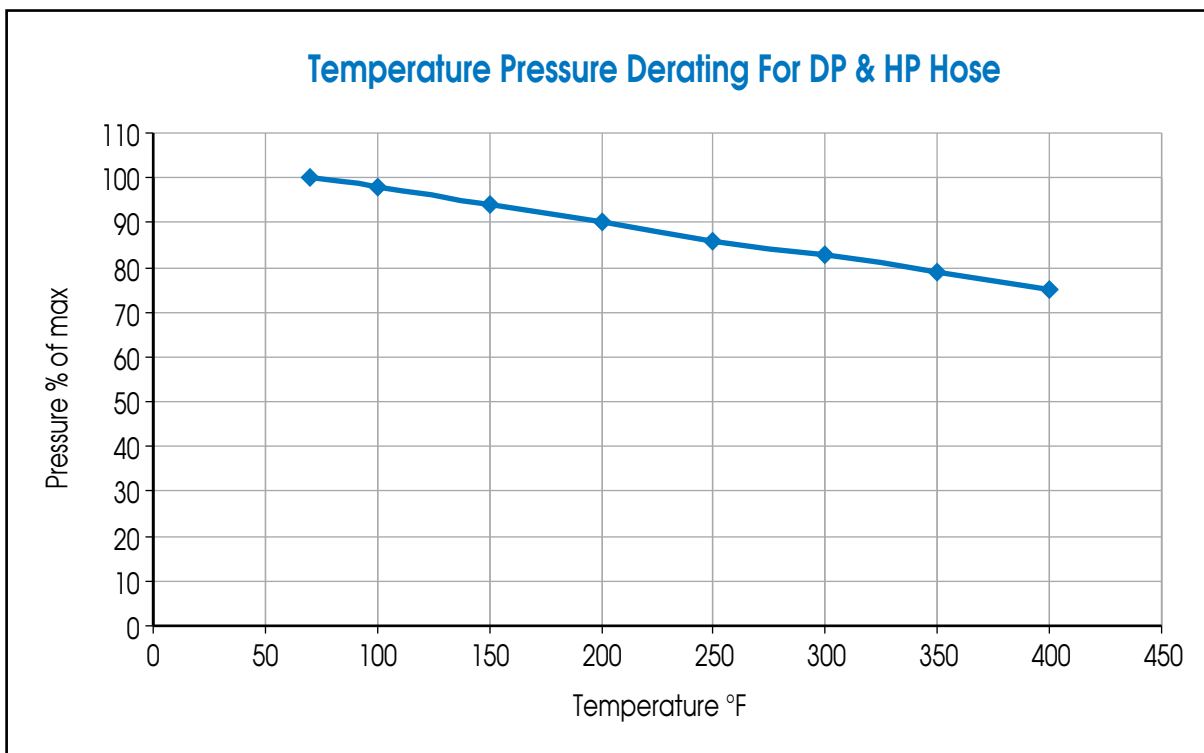

CHEMICAL RESISTANCE DATA

MATERIAL COMPATIBILITY KEY:

1. Excellent 2. Acceptable with Limited Service Life 3. Not Recommended 0. No Information, Test Before Using. Consult factory for other than room temperature applications.

EFFUSION COMPATIBILITY KEY:

- A. Will effuse and can displace breathable air in a confined space.
- B. Potential to effuse and, with atmosphere, form chemicals that can corrode braid and fitting material. Especially significant when "vapor phase" exists, I.E., when they reach their boiling point of approximately 125°F at atmospheric pressure. Hose assemblies should be used in well-vented areas only.
- C. Potential for effusion and can cause corrosion of the hose braid reinforcement and fitting material. These chemicals are all gases at atmospheric pressure and at temperatures of 56°F or lower. N/C. No change.

ELECTROSTATIC DISCHARGE:

In many industrial plants, there is an awareness that electrostatic discharge can be a hazard. This discharge is the result of two unlike materials coming into contact. This contact allows electrons from one material to move across its boundary and associate with the other. For example, electrons from steam can align with the wall of a PTFE hose. If both materials are good conductors of electricity, the positive and negative electrons flow back and forth between the chemical and hose wall, keeping them in balance. However, if one or both of them are insulators, the balance will be disrupted. As a result, chemicals such as gasoline or steam flowing through a white PTFE hose will deposit electrons on the wall of the innercore, building up static charge. When the charge exceeds the dielectric strength of the hose wall, dielectric breakdown occurs.

CHEMICAL	FITTING MATERIAL					EFFUSION
	PTFE	CS	304SS	316SS	BRASS	
Acetaldehyde	1	1	1	1	1	B
Acetic Acid Glacial	1	0	2	1	3	
Acetic Acid 30%	1	0	2	1	3	
Acetic Anhydride	1	3	2	2	3	
Acetone	1	1	1	1	1	
Acetylene	1	0	2	2	2	C
Acrylonitrile	1	0	2	2	2	
Alum Ammonium or Potassium	1	3	3	2	2	
Aluminum Acetate	1	0	1	1	3	
Aluminum Bromide	1	3	2	2	3	
Aluminum Chloride	1	3	2	2	3	
Aluminum Fluoride	1	3	2	2	3	
Aluminum Hydroxide	1	0	1	1	1	
Aluminum Nitrate	1	3	1	1	0	
Aluminum Salts	1	0	2	2	0	
Aluminum Sulfate	1	3	3	2	3	
Ammonia, Anhydrous	1	1	1	1	0	
Ammonia, Aqueous	1	0	1	1	3	
Ammonium Carbonate	0	1	1	1	0	
Ammonium Chloride	1	0	2	2	3	
Ammonium Hydroxide	1	2	1	1	3	
Ammonium Metaphosphate	1	1	1	1	0	
Ammonium Nitrate	1	1	1	1	3	
Ammonium Nitrite	0	0	1	1	3	
Ammonium Persulfate	3	0	1	1	0	
Ammonium Phosphate	1	3	2	1	0	
Ammonium Sulphate	1	3	1	1	3	
Ammonium Thiocyanate	1	3	3	1	0	
Amyl Acetate	1	3	1	1	2	
Amyl Alcohol	1	2	1	1	1	
Amyl Chloride	1	1	1	1	1	
Amyl Chloronaphthalene	1	0	1	1	0	
Amyl Naphthalene	1	0	1	1	0	
Aniline 1	2	1	1	3		
Aniline Dyes	1	3	1	1	3	
Aniline Hydrachloride	1	3	3	3	3	
Animal Fats	1	1	1	1	0	
Aqua Regia	1	3	2	2	3	
Arsenic Acid	1	3	3	1	2	
Askarel	0	1	1	1	1	

CHEMICAL	FITTING MATERIAL					EFFUSION
	PTFE	CS	304SS	316SS	BRASS	
Asphalt	1	1	1	1	1	
Barium Carbonate	1	2	1	1	1	
Barium Chloride	1	2	1	1	2	
Barium Hydroxide	1	3	1	1	3	
Barium Sulfate	1	1	1	1	2	
Barium Sulfide	1	3	1	1	3	
Beer	1	2	1	1	1	
Beet Sugar Liquors	1	1	1	1	0	
Benzene	1	1	1	1	1	
Benzenesulfonic Acid	0	3	2	2	2	
Benzaldehyde	1	2	1	1	1	
Benzine	1	1	1	1	1	B
Benzyl Alcohol	1	2	1	1	1	
Benzyl Benzoate	1	1	1	1	0	
Benzyl Chloride	1	1	0	0	0	
Bismuth Carbonate	1	1	1	1	0	
Black Sulphate Liquor	1	2	2	1	3	
Blast Furnace Gas	1	1	1	1	1	C
Borax	1	2	1	1	1	
Bordeaux Mixture	1	0	1	1	0	
Baric Acid	1	3	1	1	2	
Bunker Oil	1	1	1	1	1	
Butadine	1	1	1	1	1	
Butane	1	1	1	1	1	C
Butter Oil	1	1	1	1	1	
Butyric Acid	1	3	1	1	2	
Butyl Acetate	1	2	1	1	2	
Butyl Alcohol	1	1	1	1	1	
Butyl Amine	0	1	1	1	1	
Butyl Carbitol	1	1	1	1	1	
Butyl Stearate	1	1	1	1	1	
Butyl Mercaptan	1	0	1	1	0	
Butraldehyde	1	0	0	0	1	
Calcium Acetate	1	1	1	1	1	
Calcium Bisulfate	1	0	2	1	3	
Calcium Bisulfite	1	3	1	1	3	
Calcium Carbonate	1	2	1	1	3	
Calcium Chlorate	1	2	2	1	2	
Calcium Chloride	1	3	2	1	2	
Calcium Hydroxide	1	3	1	1	3	

CHEMICAL	FITTING MATERIAL					EFFUSION
	PTFE	CS	304SS	316SS	BRASS	
Calcium Hypochlorite	1	3	2	2	3	
Calcium Nitrate	1	2	1	1	1	
Calcium Silicate	1	1	1	1	1	B
Calcium Sulfate	1	1	1	1	1	
Calcium Sulfide	1	1	1	1	0	
Cane Sugar Liquors	1	1	1	1	2	
Carbolic Acid	1	3	1	1	3	
Carbon Dioxide	1	1	1	1	1	A
Carbon Disulfide	0	2	1	1	2	
Carbonic Acid	1	3	1	1	3	
Carbon Monoxide	1	1	1	1	1	C
Carbon Tetrachloride	1	2	1	1	2	
Castor Oil	1	1	1	1	1	
Caustic Soda	1	2	1	1	3	
Cellosolve, Acetate	1	0	2	2	1	
Cellosolve, Butyl	1	1	1	1	1	
Cellulube	1	1	1	1	1	
Chlorine, Gaseous, Dry*	*	2	3	3	2	C
Chlorine, Gaseous, Wet*	*	3	3	3	3	B
Chlorine Trifluoride	0	3	0	0	0	C
Chloroacetic Acid	1	3	3	3	3	
Chlorobenzene	1	1	1	1	1	
Chlorobromomethane	1	1	1	1	1	
Chloroform	1	1	1	1	1	
O-Chloronaphthalene	1	1	1	1	1	
Chlorotoluene	1	1	1	1	1	
Chromic Acid	1	3	3	2	3	
Citric Acid	1	3	3	1	3	
Cod Liver Oil	1	1	1	1	1	
Coke Oven Gas	1	1	1	1	0	
Compressed Natural Gas (CNG)¹	0	1	1	1	2	A1
Copper Chloride	1	3	3	1	3	
Copper Cyanide	1	0	1	1	3	
Copper Sulfate	1	3	1	1	3	
Corn Oil	1	1	1	1	1	
Corn Syrup	1	1	1	1	0	
Cottonseed Oil	1	1	1	1	1	
Creosote	1	2	1	1	3	
Cresol	1	2	1	1	0	
Crude Wax	1	1	1	1	1	

CHEMICAL RESISTANCE DATA

CHEMICAL	FITTING MATERIAL					EFFUSION
	PTFE	CS	304SS	316SS	BRASS	
Cutting Oil	1	1	1	1	1	
Cyclohexane	1	1	1	1	1	
Cyclohexanone	1	0	1	1	0	
Cymene	1	0	0	0	1	
Decaline	1	0	0	0	1	
Denatured Alcohol	1	1	1	1	1	
Diacetone	1	1	1	1	1	
Diacetone Alcohol	1	1	1	1	1	
Dibenzyl Ether	1	1	1	1	1	
Dibutyl Ether	1	1	1	1	1	
Dibutyl Phthalate	1	1	1	1	1	
Dibutyl Sebacate	1	1	1	1	1	
Dichlorobenzene	1	0	1	1	1	
Diesel Oil	1	1	1	1	1	
Diethylamine	1	3	0	2	3	
Diethyl Ether	1	1	1	1	1	B
Diethylene Glycol	1	1	1	1	1	
Diethyl Phthalate	1	0	1	1	1	
Diethyl Sebacate	1	0	1	1	1	
Di-Isobutylene	0	0	1	1	1	
Di-Isopropyl Keytone	1	0	1	1	1	
Dimethyl Aniline	1	0	0	0	1	
Dimethyl Formamide	0	1	1	1	0	
Dimethyl Phthalate	1	0	0	0	1	
Diocetyl Phthlate	1	1	1	1	1	
Dioxane	1	1	1	1	1	
Dipentene	1	1	1	1	1	
Ethanolamine	1	1	1	1	1	
Ethyl Acetate	1	1	1	1	1	
Ethyl Acetoacetate	1	1	1	1	1	
Ethyl Atrylate	0	1	1	1	0	
Ethyl Alcohol	1	1	1	1	1	
Ethyl Benzene	1	1	1	1	1	
Ethyl Cellulose	1	1	1	1	1	
Ethyl Chloride	1	2	1	1	2	
Ethyl Ether	1	2	1	1	2	
Ethyl Mertaptan	1	2	0	0	2	B
Ethyl Pentochlorobenzene	1	2	1	1	1	
Ethyl Silicate	1	1	1	1	1	
Ethylene Chloride	1	2	1	1	2	
Ethylene Chlorohydrin	1	0	0	0	0	
Ethylene Diamine	1	0	1	0	1	
Ethylene Glycol	1	2	1	1	1	
Fatty Acids	1	0	1	1	0	
Ferric Chloride	1	3	3	3	3	
Ferric Nitrate	1	3	1	1	0	
Ferric Sulfate	1	3	1	1	3	
Ferrous Chloride	1	3	1	2	2	
Ferrous Nitrate	1	3	1	1	3	
Ferrous Sulfate	1	3	1	1	2	
Fluoroboric Acid	1	0	1	1	0	
Formaldehyde	1	2	1	1	2	
Formic Acid	1	3	2	1	2	
Freon 12	2	3	1	1	0	A
Freon 21	2	3	1	1	0	A

CHEMICAL	FITTING MATERIAL					EFFUSION
	PTFE	CS	304SS	316SS	BRASS	
Freon 22	2	3	1	1	0	A
Freon 113	2	3	1	1	0	A
Freon 114	2	3	1	1	0	A
Fuel Oil	1	1	1	1	1	
Fumaric Acid	0	0	1	1	0	
Furon Furfuran	1	1	1	1	1	
Furfural	1	2	1	1	1	
Gallic Acid	1	3	1	1	0	
Gasoline	1	1	1	1	1	
Glauber's Salt	0	1	1	1	0	
Glucose	1	1	1	1	1	
Glue	1	2	1	1	1	
Glycerin	1	2	1	1	1	
Glycols	1	1	1	1	1	
Green Sulfate Liquor	1	1	1	1	0	
n--Hexaldehyde	1	1	1	1	1	
Hexane	1	1	1	1	1	
Hexene	1	1	1	1	1	
Hexyl Alcohol	1	1	1	1	2	
Hydraulic Oil, Petroleum	1	1	1	1	1	
Hydrochloric Acid, 15%	1	3	3	3	3	B
Hydrochloric Acid, 37%	1	3	3	3	3	B
Hydrochromic Acid	1	3	3	3	3	
Hydrofluoric Acid, Concentrated	1	3	3	3	3	
Hydrofluosilicic Acid	1	0	2	2	3	
Hydrogen, Gaseous	**	1	1	1	1	C
Hydrogen Peroxide, 70%	1	2	3	1	3	
Hydrogen Sulfide, Gaseous	1	3	2	1	3	C
Hydroquinone	0	1	1	1	0	
Isobutyl Alcohol	1	1	1	1	1	
Iso Octane	1	1	1	1	1	
Isopropyl Acetate	1	1	1	1	1	
Isopropyl Alcohol	1	1	1	1	1	
Isopropyl Ether	1	1	1	1	1	
JP3 Fuel	1	1	1	1	1	
JP4 Fuel	1	1	1	1	1	
JP5 Fuel	1	1	1	1	1	
JP6 Fuel	1	1	1	1	1	
JP8 Fuel	1	1	1	1	1	
Kerosene	1	1	1	1	1	
Ketones	1	1	1	1	1	
Lacquers	1	3	3	1	1	
Lacquer Solvents	1	3	3	1	1	B
Lactic Acid	1	3	2	1	2	
Lard	1	1	1	1	3	
Lead Acetate	1	3	0	1	1	
Lead Nitrate	0	1	1	1	0	
Lime Bleath	0	3	2	1	0	
Linoleic Acid	1	3	2	2	3	
Linseed Oil	1	1	1	1	1	
Lubricating Oils, Petroleum	1	1	1	1	1	
Magnesium Chloride	1	3	3	3	2	
Magnesium Hydroxide	1	1	1	1	0	
Magnesium Sulfate	1	1	1	1	1	
Molic Acid	1	2	2	1	0	

CHEMICAL	FITTING MATERIAL					EFFUSION
	PTFE	CS	304SS	316SS	BRASS	
Mercuric Chloride	1	3	1	1	3	
Mercury	1	1	1	1	3	
Mesityl Oxide	1	1	1	1	1	
Methyl Acetate	1	2	1	1	1	
Methyl Atrylote	0	1	1	1	1	
Methyl Alcohol	1	1	1	1	2	
Methyl Bromide	1	0	2	2	0	B
Methyl Butyl Ketone	0	1	1	1	1	
Methyl Chloride	1	1	1	1	1	B
Methylene Chloride	1	1	1	1	3	
Methyl Ethyl Ketone (MEK)	1	1	1	1	1	
Methyl Formate	1	0	1	1	3	B
Methyl Isobutyl Ketone	1	1	1	1	1	
Methyl Methacrylate	1	1	1	1	0	
Methyl Salicylate	1	1	1	1	1	
Milk	1	3	1	1	3	
Mineral Oil	1	1	1	1	1	
Monochlorobenzene	1	1	1	1	1	
Monoethanolamine	0	1	1	1	1	
Naphtha	1	2	1	1	1	
Naphthalene	1	2	2	2	0	
Naphthenic Acid	1	0	2	1	0	
Natural Gas†	0	1	1	1	2	A†
Nickel Acetate	1	1	1	1	1	
Nickel Chloride	1	3	2	2	3	
Nickel Sulfate	1	0	2	1	3	
Niter Coke	0	3	2	1	0	
Nitric Acid, All Concentrations	1	3	2	2	3	
Nitric Acid, Red Fuming	1	3	3	2	3	
Nitrobenzene	1	1	1	1	1	
Nitroethane	1	0	1	1	1	
Nitrogen, Gaseous	1	1	1	1	1	A
Nitrogen Telroxide	0	0	0	2	0	
n-Octane	0	1	1	1	1	
Octyl Alcohol	1	3	1	1	2	
Oil, SAE	1	1	1	1	1	
Oleic Acid	1	3	3	1	2	
Olive Oil	1	1	1	1	1	
Oxalic Acid	1	3	1	1	3	
Oxygen, Gaseous****	1	1	1	1	1	A
Ozone	1	1	1	1	1	
Paint	1	1	1	1	1	
Palmitic Acid	1	2	1	1	1	
Peanut Oil	1	1	1	1	1	
Perchloric Acid	1	0	2	2	0	
Perchloroethylene	1	2	1	1	1	
Petroluem	1	1	1	1	1	
Phenol	1	3	1	1	3	
Phorone	1	1	1	1	1	
Piric Acid	1	3	1	1	3	
Pinene	1	1	1	1	1	
Pine Oil	1	2	1	1	0	
Plating Solution, Chrome	1	0	3	3	0	
Potassium Acetate	1	3	2	2	0	
Potassium Chloride	1	1	2	2	2	

CHEMICAL RESISTANCE DATA & TEMPERATURE/OPERATING PRESSURE

CHEMICAL	FITTING MATERIAL					EFFUSION	CHEMICAL	FITTING MATERIAL					EFFUSION	CHEMICAL	FITTING MATERIAL					EFFUSION
	PTFE	CS	304SS	316SS	BRASS			PTFE	CS	304SS	316SS	BRASS			PTFE	CS	304SS	316SS	BRASS	
Potassium Cyanide	1	2	1	1	3		Sodium Cyanide	1	2	1	1	3		Tanic Acid, 10%	1	2	1	1	3	
Potassium Dichromate	1	3	1	1	0		Sodium Hydroxide, 40%	1	2	1	1	3		Tar, Bituminous	1	1	1	1	2	
Potassium Hydroxide, 30%	1	3	1	1	3		Sodium Hypochlorite	1	3	3	2	3		Tartaric Acid	1	3	1	1	3	
Potassium Nitrate	1	3	1	1	2		Sodium Metaphosphate	1	3	1	1	3		Terpineol	1	0	0	0	0	
Potassium Sulfate	1	1	1	1	2		Sodium Nitrate	1	1	1	1	2		Titanium Tertachloride	0	3	2	2	3	
Propane	1	1	1	1	1	A	Sodium Perborate	1	3	1	1	3		Toluene	1	1	1	1	1	
Propyl Acetate	0	1	1	1	1		Sodium Peroxide	1	3	1	1	3		Toluene Diisocyanate	0	0	0	0	0	
Propyl Alcohol	1	1	1	1	1		Sodium Phosphate	1	2	1	1	3		Transformer Oil	1	1	1	1	1	
Pyridine, 50%	1	1	1	1	1		Sodium Thiosulfate	1	3	1	1	3		Transmission Fluid, Type A	1	1	1	1	1	
Red Oil	1	2	2	1	2		Soybean Oil	1	1	1	1	0		Tributoxyethyl Phosphate	1	0	1	1	0	
Salicylic Acid	0	3	1	1	0		Stannic Chloride	1	3	3	3	3		Tributyl Phosphate	1	1	0	0	0	
Salt Water	1	3	3	2	3		Steam	1	3	1	1	1	A	Trichloroethylene	1	2	1	1	1	
Sewage	1	3	1	1	1		Stearic Acid	1	3	2	1	3		Tricresyl Phosphate	1	1	0	2	0	
Silicon Tetrafluoride (STF)	0	3	2***	2***	3	C	Stoddard Solvent	1	1	1	1	1		Tung Oil	1	1	1	1	1	
Silicone Greases	0	1	1	1	1		Styrene	1	2	0	2	2		Turpentine	1	1	1	1	2	
Silicone Oils	0	1	1	1	1		Sucrose Solution	1	1	1	1	1		Urea Solution, 50%	1	1	1	1	0	
Silver Nitrate	1	3	1	1	3		Sulfur, 200° F	1	3	1	1	3		Varnish	0	3	1	1	2	
Skydrol 500 & 7000	1	1	1	1	0		Sulfur Chloride	1	3	3	2	3		Vegetable Oils	1	1	1	1	1	
Soap Solutions	1	1	1	1	1		Sulfur Dioxide	1	2	1	1	1	C	Versilube	1	1	1	1	1	
Soda Ash	1	1	1	1	2		Sulfur Trioxide	1	3	2	2	3	B	Vinegar	1	3	1	1	3	
Sodium Acetate	1	3	1	1	0		Sulfuric Acid, 10%	1	3	2	3	3		Vinyl Chloride	1	2	1	1	3	C
Sodium Bicarbonate	1	3	1	1	2		Sulfuric Acid, 98%	1	2	3	2	3		Water	1	2	1	1	1	
Sodium Bisulfite	1	3	1	1	3		Sulfuric Acid, Fuming	1	3	3	2	3		Whiskey, Wines	1	3	2	1	3	
Sodium Borate	1	1	1	1	0		Sulfurous Acid, 10%	1	3	2	1	3		Xylene	1	2	2	2	3	
Sodium Chloride	1	2	2	2	1		Sulfurous Acid, 75%	1	3	3	2	3		Zinc Acetate	1	1	1	1	1	
														Zinc Chloride	1	3	2	1	3	
														Zinc Sulfate	1	3	2	1	3	

Fitting material ratings are based on a fluid temperature of 70°F. Higher temperatures may accelerate adverse effects. Consult US Hose engineering.

1 Consult US Hose engineering

* Refer to page 17 for chlorine/bromine hose. Do not use stainless steel braided PTFE hose.

** Caution: explosive, consult US Hose engineering.

*** Highly corrosive, consult US Hose engineering

**** Special cleaning required. Consult US Hose engineering

SIZE	TEMPERATURE/OPERATING PRESSURE: Smooth bore thin wall PTFE Hose, Smooth bore Heavy wall PTFE Hose								
	65 F° 18.3 C°	100 F° 37.8 C°	150 F° 65.6 C°	200 F° 93.3 C°	250 F° 121.1 C°	300 F° 148.9 C°	350 F° 176.7 C°	400 F° 204.4 C°	450 F° 232.0 C°
-3, -4, -5	3000	2922	2810	2698	2586	2474	2362	2250	2138
-6	2500	2435	2341	2248	2155	2062	1968	1875	1782
-8	2000	1948	1873	1799	1724	1649	1575	1500	1425
-10	1500	1461	1405	349	1293	1237	1181	1125	1069
-12	1200	1169	1124	1079	1034	990	945	900	855
-16, -20Z	1000	974	937	899	862	825	787	750	713

SIZE	TEMPERATURE/OPERATING PRESSURE: Dense-Pac Hose								
	65 F° 18.3 C°	100 F° 37.8 C°	150 F° 65.6 C°	200 F° 93.3 C°	250 F° 121.1 C°	300 F° 148.9 C°	350 F° 176.7 C°	400 F° 204.4 C°	450 F° 232.0 C°
-4, -6, -8, -10, -12, -16	5000	4869	4683	4496	4310	4123	3937	3750	3563

SIZE	TEMPERATURE/OPERATING PRESSURE: WCV/BCV Hose								
	65 F° 18.3 C°	100 F° 37.8 C°	150 F° 65.6 C°	200 F° 93.3 C°	250 F° 121.1 C°	300 F° 148.9 C°	350 F° 176.7 C°	400 F° 204.4 C°	450 F° 232.0 C°
-3, -4, -5	1000	974	937	899	862	825	787	750	713
-6	750	730	702	674	646	618	590	563	535
-8	500	487	468	450	431	412	394	375	356



These products can be used to convey hazardous fluids, steam, and other dangerous materials which can cause personal injury or property damage if released through misuse, misapplication, or damaged. The user is responsible to analyze each application prior to specifying any product from this catalog. Due to the wide variety of operating conditions and applications, the user, through personal analysis and testing, is solely responsible for final product selection and meeting all performance, safety, and warning requirements. Careful selection, proper assembly and use of hose fittings and accessories is essential for the safe and warranted operation of the hose assembly.

Worldwide Leader for Hose of . . .

Willcox Hose®

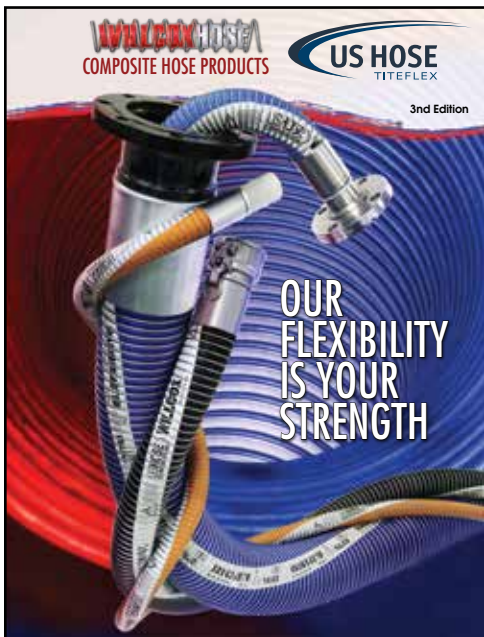

815 Forestwood Drive
Romeoville, Illinois 60446
815/886-1140
800/473-0474
Fax 815/886-4550

TIFT-Compoflex®

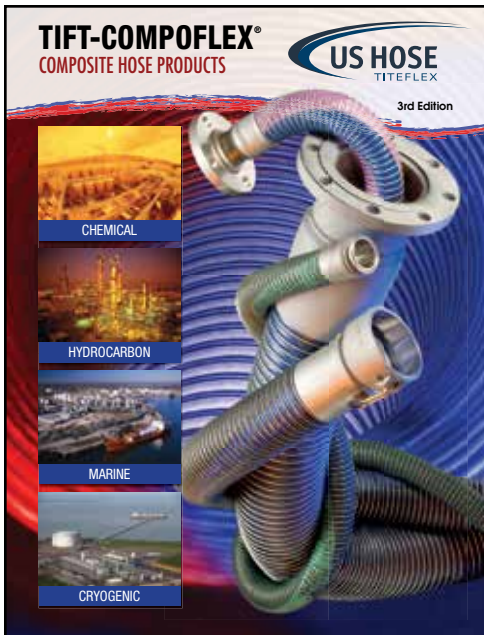

2020 Green Road
Suite 400
Houston, Texas 77032
888/919-0400 • Fax 281-458-7809
281/458-0400

Fluoropolymer



Metal

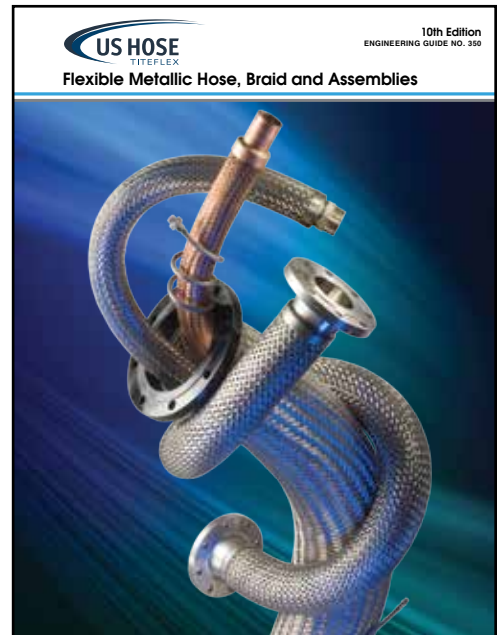

MEMBER OF:



Specifications subject to change without notice.
Printed in U.S.A. ©2014 US Hose Corporation

©2020 - 208047 r2