

UNITED FLEXIBLE

Engineering Guide No. 350

Flexible Metallic Hose, Braid and Assemblies



UNITED FLE>XIBLE

Your one source for all your flexible requirements:

Metal, composite and fluoropolymer hose, tubing, bellows and assemblies

The strengths of five flexible fluid control companies – US Hose Corp., AmniTec Ltd, AmniTec BV, Habia Teknofluor AB and Fulton Bellows LLC – are being combined into a new company and new brand called United Flexible. United Flexible manufactures and markets a wide range of metallic braided, composite and fluoropolymer hose and tubing, precision bellows and engineered assemblies.

The new United Flexible reflects our commitment to provide you solutions expertise, high-quality products and the premier customer service you expect. With your input, we're continuing to broaden our portfolio of products and assemblies for your diverse applications needs. To meet your evolving needs, United Flexible brings you deep expertise in gas and fluid transfer applications, plus collaborative engineering resources and unique manufacturing processes.

To see the full breadth of our product and assembly capabilities, we invite you to visit our new website at www.unitedflexible.com. There you'll find new product catalogs and the widest range of flexible fluid transport solutions we've ever offered.

"Our Flexibility Is Your Strength."

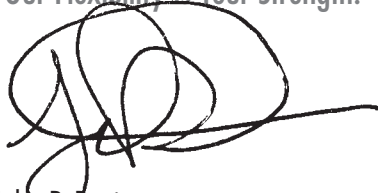

John P. Devine
Chief Executive
United Flexible

TABLE OF CONTENTS

Description	Page
Metal Hose and Assembly Design	
STAMPED Design and Application Guide	4
Size Selection Factors	5
Temperature Selection Factors	6
Alloy Selection Factors	7-11
Motion Selection Factors	12-13
Pressure Selection Factors	14
End Selection Factors	15-17
Distance Selection Factors	18-19
Engineering Design Services	20
Special Assemblies	21
Product Lines, Pressure Ratings and Technical Data	
Metal Hose Standard Product Lines	22-23
Metal Hose Product Technical Data	24-57
Interlock Hose	58-59
Assembly Fabrication	
Assembly Customization	60-61
Assembly Schematic	62-63
Installation Guide	64-65
Handling Guide	66
Inspection Guide	67
Reference Information	
Reference Data	68-69
Additional Information	
Certification	70
Notes	71
Contact Information	Back Cover

KEEP WATCH FOR:

Case Studies and Interesting Facts throughout this Engineering Guide



STAMPED Design and Application Guide

The selection of the correct metal hose is critical to insure optimum field performance. To accomplish this, there are a number of important application requirements that must be known. The guide below will help you identify the requirements, and design the most effective, engineering sound product.

The word "STAMPED" is useful as a checklist of application requirements to be checked.

CONSIDER	CHECK FOR ...
S ize	Inside Diameter (I.D.) Outside Diameter (O.D.)
T emperature	of Material being Conveyed (High, Low, Ambient) of Outside Environment (High, Low, Ambient) Intermittent or Constant
A lloy	Service Temperature Range Strength Corrosion Resistant Chemical Compatibility
M otion	Static (one Time Routing) or Dynamic Motion (Flexing and Cycling) Vibration Minimum Bend Radius
P ressure	Maximum Working Pressure Safety Factor and Burst Pressure Flow Rate Impulse or Pressure Surges
E nds	Male or Female Fitting Type and Material Swivel or Non Swivel Orientations and Alignment
D istance	Hose Length (Overall, Live Length, Seat to Seat) Tolerances

NOTICE: This Engineering Guide No. 350 is to assist you in the selection and application of flexible metal hose for your particular requirements. The information and data contained in this Engineering Guide are the result of years of our experience and research in flexible metal hose. As such it is the best information and data available to us as of the data printing. Progress is part of any dynamic program or research and development, such as the Company sponsors, so that all information and data contained herein are subject to change (without notice) at any time.

Should you be unable to determine a specification for a particular application, we solicit receiving details describing the application so that we may make a recommendation. Because we do not supervise or control the installation and use of our products, we cannot be responsible for their performance or for the improper application and usage of the data.

Size Selection Factors

Size STAMPED

Hose Diameter

Inner diameter refers to the free cross-section of the hose and is also named Nominal diameter. It indicates the approximated inside diameter and guarantees that parts with the same nominal diameter will fit together. The outside diameter refers to the external diameter of metal hose, measured from the top of the corrugation (or braiding or other outside protection).

Flow Velocity

Where flow velocity exceeds 100 ft/sec (30 m/sec) gas or 50 ft/sec (15 m/sec) liquid, in unbraided hose, or 150 ft/sec (45 m/sec) gas or 75 ft/sec (22 m/sec) liquid, in braided hose, a flexible metal liner of fully interlocked hose should be used. When the hose is installed in a bent condition, these flow values should be reduced by 50% for a 90° bend, 25% for a 45° bend, and so on, proportional to the angle of bend. In cases where velocity exceeds the above values, the next larger size corrugated hose should be used with the flexible RT liner size equivalent to the mating pipe size.

Pressure Drop

Where the amount of pressure drop through longer lengths of hose is a significant factor, a larger diameter hose may be required. As a broad rule of thumb, pressure drop through a corrugated metal hose is approximately three times that in comparable size standard steel pipe. For more accurate calculations of pressure drop, consult United Flexible Engineering Group.

Corrugation Profile

Annular Profile - Independent corrugations, straight and parallel.

Helical Profile - One continuous corrugation that spirals around the hose.

**Helical Hose Construction
in Profile w/Single Layer of Braid**

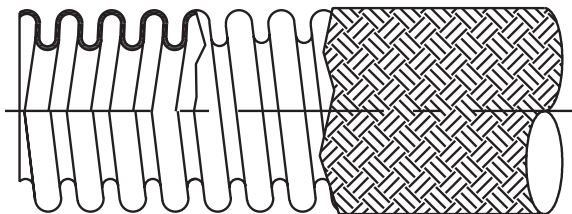

**Annular Hose Construction
in Profile w/Single Layer of Braid**

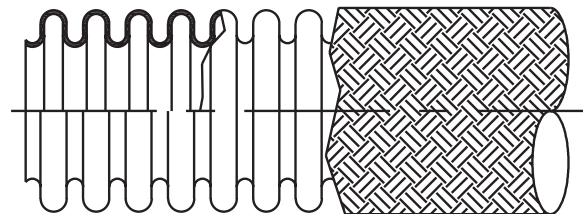

Movable Skids To solve alignment differences in movable skids that transport crude oil, gases and water, we developed innovative stainless steel hoses, which maximize efficiency and minimize footprint for the electrical tracing cable by using a special "hose saddle." Our custom assembly is easy to connect, saving time and space.

Temperature Selection Factors

STAMPED Temperature

Maximum Service Temperatures of Materials

Alloy	Max Temp °F	Max Temp °C
Hastelloy® C276	2000	1093
Inconel® 625	1800	982
AISI Stainless Steel Type:		
321	1500	815
316 ELC	1500	815
304L	1500	815
304	850	454
302	850	454
Mild Steel	850	454
Malleable Iron	800	427
Monel®	800	427
Bronze	450	232
Brass	450	232
Copper	400	204
Brazing (RCuZn-c or BCuP-2) Bronze Hose	450	232
Silver Brazing (AWS-Bag-2)	600	315
Aluminum 52S-0 (5052-0)	600	315
Galvanizing	450	232
Soft Solder		
(Pb: 60, Sn:40)	250	121
(PB: 95, Sn: 5)	350	177
Silicone Coated Fiberglass	600	315
Aluminized Fiberglass	1000	538

Maximum Service Temperatures of Materials

Operating temperature at which the material will operate effectively, which varies based on the application. Outside this range of safe operating temperatures the hose and braid may fail.

Temperature Derating

Temperature		Material				
°F	°C	Stainless Steel	Steel	Monel	Bronze	Inconel
70	20	1.00	1.00	1.00	1.00	1.00
150	66	0.97	0.99	0.93	0.92	0.97
200	93	0.94	0.97	0.90	0.89	0.94
250	121	0.92	0.96	0.87	0.86	0.92
300	150	0.88	0.93	0.83	0.83	0.88
350	177	0.86	0.91	0.82	0.81	0.86
400	200	0.83	0.87	0.79	0.78	0.83
450	232	0.81	0.86	0.77	0.75	0.81
500	260	0.78	0.81	0.73	—	0.78
600	316	0.74	0.74	0.72	—	0.74
700	371	0.70	0.66	0.71	—	0.70
800	427	0.66	0.52	0.70	—	0.66
900	482	0.62	0.50	—	—	0.62
1000	538	0.60	—	—	—	0.60
1100	593	0.58	—	—	—	0.58
1200	649	0.55	—	—	—	0.55
1300	704	0.50	—	—	—	0.50
1400	760	0.44	—	—	—	0.44
1500	815	0.40	—	—	—	0.40
1800	0.40	0.40	—	—	—	0.40

Temperature Derating

For operating temperatures in excess of 70°F (21°C), the tabulated pressures must be decreased in accordance with the “Conversion Factors” listed in the table below. Since the pressure ratings are based on annealed material properties, no reduction in pressure rating is necessary for fitting attachment by TIG welding, brazing, or soft solder.

Consult United Flexible Engineering Group whenever service conditions necessitate consideration of the influence of long time exposure at elevated temperature. Consult factory for maximum temperature of Hastelloy® materials.

Alloy Selection Factors

STAlloyMPED

T-300 Series Stainless Steel (Austenitic)

The general grouping of the austenitic stainless steels are 302, 303, 304, 304L, 316, 316L, 316Ti, 321, 347 etc. . .

T-304 Stainless Steel UNS S30400 / EN 1.4301

T-304 is the most commonly used stainless in the world can comely referred to as 18/8. It is weldable, machinable with the right techniques, and has good corrosion resistance.

T-304L Stainless Steel UNS S30403 / EN 1.4307

T-304L has reduced or low carbon to eliminates carbide precipitation due to welding so the alloy can be used in the "as welded" condition even in severe corrosive conditions.

T-316 Stainless Steel UNS S31600 / EN 1.4401

T316 stainless steel is 18/8 with the inclusion of molybdenum (Mo) in the alloy. To give better overall corrosion resistant properties than Grade 304, particularly higher resistance to pitting and crevice corrosion in chloride environments.

T-316L Stainless Steel UNS S31603 / EN 1.4404

T-316L has reduced or low carbon to eliminates carbide precipitation and offers higher creep, stress to rupture and tensile strength at elevated temperatures.

T-321 Stainless Steel UNS S32100 / EN 1.4541

Type 321 is an austenitic chrome nickel steel stabilized with titanium.

This material has similar properties to alloy 304, but its titanium content limits carbide precipitation, making it somewhat easier to machine. This grade is recommended for parts fabricated by welding which cannot be subsequently annealed.

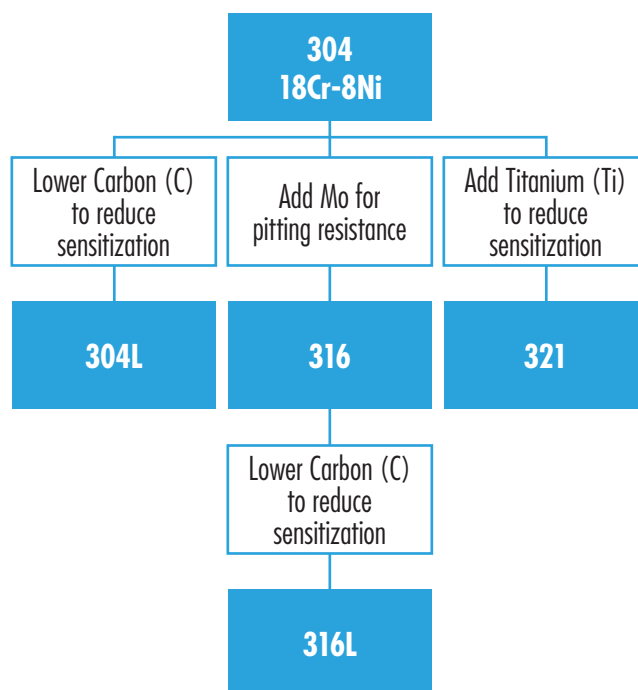

Bronze®

Alloy consisting of primarily copper (Cu) and around 12% tin (Sn) alloy

Monel® 400. UNS N04400 / EN 2.4360

A high nickel-copper alloy which offers superior strength and corrosion resistance with a wide range of media including seawater and chlorine.

Inconel® 625. UNS N06625 / EN 2.4856

A nickel-chromium-molybdenum super alloy with an addition of niobium that acts with the molybdenum to stiffen the alloy matrix and provides ultra-high strength without the need for heat treatment. This material provides superior resistance to pitting and crevice corrosion.

Hastelloy® C-276. UNS N10276 / EN 2.4819

A nickel-chromium-molybdenum super alloy with addition of tungsten designed to have excellent corrosion resistance for severe environments Especially resistant to pitting and crevice corrosion. Resistant to the formation of grain boundary precipitants in the heat affected zone making it suitable for most chemical process applications in an as-welded condition.

Need to know performance against specific chemical? See our corrosion charts on the following pages or contact our sales department.

Alloy Selection Factors (continued)

STAlloyAMPED

Chemical Resistance Tables

These charts contain recommendations based on published corrosion data for valid laboratory or field tests. However, this data should be used only as a guide and is not a guarantee of actual service performance. It is recommended that the used test the combination before connecting the product to any application. For additional information please contact our Sales or Engineering department.

NACE MR0175-2009/ISO 15156-2009 Compliance

Materials United Flexible specifies and uses in the manufacturing of hose and braid are compliant to NACE MR0175-2009/ISO 15156-2009 for use in sour environments as defined.

Austenitic stainless steels of the grades listed below meet the requirements of NACE MR0175-2009/ISO 15156-2009 Section A.2.1 for use in sour environments as defined by Tables A.2 through A.7.

T-304 (UNS S30400)

T-304L (UNS S30403)

T-316 (UNS S31600)

T-316L (UNS S31603)

T-321 (UNS S32100)

High Alloy Austenitic stainless steels of the grades listed below meet the requirements of NACE MR0175-2009/ISO 15156-2009 Section A.3.1 and Table A.8 material type 3a for use in sour environments as defined by Tables A.8 through A.11

Inconel 600 (UNS N06600)

Inconel 625 (UNS N06625)

When NASA/Boeing needed a flexible high pressure connector on a tight schedule, UF developed a very flexible hose at high pressure that meets NASA's standards and is now in use on the International Space Station. Our hose enables the ISS to process its own gases. Our hose also serves as a lifeline for astronauts. This problem had never been solved before.

Alloy Selection Factors (continued)

Index to Laboratory Corrosion Data Chart

- I. <.00035 inches in penetration/month —Resistant —Class 1
- .00035-.0035 inches in penetration/month —Partially Resistant —Class 2
- >.0035 inches in penetration/month —Not Resistant —Class 3
- II. *Subject to decomposition (forming HCl) in presence of moisture
- **Subject to pitting at air line or when allowed to dry
- ***Subject to attack in presence of H₂SO₄

B = Boiling

Corrosion Rate Typical 18-8 Stainless Steels are Types 304, 304L, 321 and 347

Typical 18-8 Mo. Stainless Steels are Types 316 and 316L

(Contact factory for other alloy recommendations)

Chemical	Temp		Stain-less Steel		Mild Steel	Brass (80-20)	Bronze (Phos.)	Monel
	°F	°C	18-8	18-8 Mo.				
Acetic Acid 5%-20% Agitated or Aerated	70	21	1	1	3	3	3	2
50%	70	21	1	1	3	3	3	3
50% - 80%	B	B	3	2	3	3	3	3
80%	70	21	1	1	3	3	3	1
100%	70	21	1	1	3	3	3	1
100%	B	B	3	2	3	3	3	2
100% — 150 lbs. pressure	400	760	3	3	3	3	3	2
Acetic Anhydride	70	21	1	1	3	3	3	2
	B	B	1	1	3	3	3	2
Acetic Acid Vapors, 30%	Hot	Hot	3	2	3	3	3	3
100%	Hot	Hot	3	3	3	3	3	2
Acetone	B	B	1	1	3	1	1	1
Acetyl Chloride	Cold	Cold	2	2	3	2	2	1
	B	B		2	3	2	2	3
Acetylene Concentrated	70	21	1	1	3	1	1	1
Commercially Pure	70	21	1	1	1	3	3	1
Acid Salt Mixture 10% H ₂ SO ₄ Sp. G. 1.07 + 10% CuSO ₄ • 5 H ₂ O	B	B	1	1	3	3	3	3
Acid Salt Mixture 10% H ₂ SO ₄ Sp. G. 1.07 + 2% FeSO ₄ • 7 H ₂ O	B	B	1	1	3	3	3	3
Alcohol, Ethyl, 70° & B	70	21	1	1	1	1	1	1
	70	21	1	1	1	1	1	1
Alcohol, Methyl	(150) B	(65) B	3**	2	3	1	1	1
Aluminum, Molten	1400	760	3	3	3	3	3	3
Aluminum Acetate, Saturated	70 & B	21 & B	1	1	3	3	3	1
Aluminum Chloride 10% Quiescent	70	21	3	3	3	3	3	2
Aluminum Chloride 25% Quiescent	70	21	1	1	3	3	3	2
Aluminum Fluoride	70	21	3	3	3	3	3	2
Aluminum Hydroxide, Saturated	70	21	1**	1	1**	1	1	1
Aluminum Sulphate, 5%	150	65	1**	1	3	3	3	1
10%	70	21	1**	1	3	3	3	1
10%	B	B	2**	1	3	3	3	1
Saturated	70	21	1**	1	3	3	3	1
Saturated	B	B	2**	1	3	3	3	1
Aluminum Potassium Sulphate (Alum) 2% - 10%	70	21	1	1	3	2	2	2
10%	B	B	2	1	3	3	3	2
Saturated	B	B	3	2	3	3	3	2
Ammonia (Anhydrous)								
All Concentrations	70	21	1	1	1	1	1	1
Gas	Hot	Hot	3	3	3	3	3	3
Ammonia Liquor	70	21	1	1	3	3	3	3
	B	B	1	1	3	3	3	3
Ammonium Bicarbonate	70	21	1	1	3	3	3	2
	Hot	Hot	1	3	3	3	3	2
Ammonium Bromide	70	21	2	1	3	3	3	2
Ammonium Carbonate 1 & 5%	70	21	1	1	1	3	3	3
Ammonium Chloride 1%	70	21	1	1	2	3	3	1
10%	B	B	1**	1**		3	3	2
28%	B	B	2**	1**		3	3	2
50%	B	B	2**	1**		3	3	2
Ammonium Hydroxide All Concentrations	70	21	1	1	2	3	3	3
Ammonium Monophosphate	70	21	1	1	2	3	3	2
Ammonium Nitrate								
All Concentrate Agitated	70	21	1	1	3	3	3	2
All Concentrate Aerated	70	21	1	1	3	3	3	2
All Concentrate Saturated	B	B	1	1	3	3	3	2
Ammonium Oxalate 5%	70	21	1	1	2	3	3	-
Ammonium Perchlorate 10%	B	B	1	1	2	3	3	-

Chemical	Temp		Stain-less Steel		Mild Steel	Brass (80-20)	Bronze (Phos.)	Monel		
	°F	°C	18-8	18-8 Mo.						
Ammonium Persulphate 5%	70	21	1	1		3	3	3		
Ammonium Phosphate 5%	70	21	1	1	2	3	3	3		
Ammonium Sulphate										
1% Aerated or Agitated	70	21	1	1	3	3	3	2		
Ammonium Sulphate										
5% Aerated & Agitated	70	21	1	1	3	3	3	2		
10% & Saturated	B	B	2**	1**	3	3	3	2		
Ammonium Sulphite, 70° & Boiling	70	21	1	1	3	3	3	3		
Amyl Acetate Concentrate	70	21	1	1	2	1	1	1		
Amyl Chloride	70	21	1	1	3	2	2	2		
Aniline 3%	70	21	1	1	2	3	3	2		
Aniline Concentrated Crude	70	21	1	1	1	3	3	2		
Aniline Hydrochloride	70	21	3	3		3	3	3		
Antimony Trichloride	70	21	3	3	3	3	3	3		
Barium Carbonate	70	21	1	1	2	1	1	2		
Barium Chloride 5% & Saturated	70	21	1	1	3	2	2	2		
Barium Hydroxide Aqueous Solution	Hot	Hot	1	1	2	1	1	2		
Barium Nitrate Aqueous Solution	Hot	Hot	1	1	2			-		
Barium Sulphate (Barytes-Blanc Fixe)	70	21	1	1		1	1	2		
Barium Sulphide Saturated Solution	70	21	1	1	3	3	3	-		
Beer (Barley Malt & Hops)	70	21	1	1	3	1	1	1		
3.5% - 4.5% Alcohol	160		1	1	3	1	1	1		
Benzene (Benzol) 70° or Hot	70	21	1	1	2	1	1	2		
Benzoic Acid	70	21	1	1	1	1	1	-		
Blood (Meat Juices)	Cold	Cold	1**	1	2			2		
Borax 5%	Hot	Hot	1	1	2	1	1	2		
	Hot	Hot	1	1						
Boracic Acid 5%	Cold	Cold	1	1						
Boric Acid, 5% Solution, 70° or Hot	70	21	1	1	3	1	1	2		
Boric Acid, 5% Solution	B	B	1	1**	3	2	1	2		
Boric Acid, Saturated Solution	70	21	1**	1**	3	3	2	2		
	B	B	1**	1**	3	3	3	2		
Bromine, Bromine Water	70	21	3	3	3	3	3	3		
Buttermilk	70	21	1	1	3	3	3	2		
Butyl Acetate					1	1	2	2		
Butyric Acid 5%	70-150	21-65	1	1	3	2	2	2		
Butyric Acid 5% Aqueous Soln. Sp. G. .964	B	B	1	1	3	3	3	2		
Calcium Carbonate	70	21	1	1	1			1		
Calcium Chlorate Dilute Solution	70 or Hot	21 or Hot	1	1	2			2		
Calcium Chloride Dilute or Concen. Solution	70	21	2**	1**	3	2	2	3		
Calcium Chlorohypochlorite (Bleaching Powder) 1%	70	21	3	3	3	2	2	3		
(Bleaching Powder) 5%	70	21	3	3	3	2	2	3		
Calcium Hypochlorite, 2%	70	21	2**	1**	3	2	2	3		
Calcium Hydroxide, 10-20%	B	B	1	1	3	1	1	1		
Calcium Sulphate, Saturated	70	21	1	1	3	1	1	2		
Carbonic Acid Saturated Soln.	70	21	1	1	3	3	1	3		
Carbolic Acid C.P.	70 or B	21 or B	1	1	3	2	2	1		
Carbonated Water					1	1	3	2	2	3
Carbon Bisulfide	70	21	1	1	2	1	2	2	2	
Carbon Monoxide Gas	1400 1600	760 871	1	1	1	3	3	1	1	
Carbon Tetrachloride C.P.	70	21	1	1	2	1	1	1	1	
Carbon Tetrachloride Dry C.P.	B	B	1	1	2	1	1	2	2	
Carbon Tetrachloride Commercial + 1% Water					3**	3	3	2	2	2
Camallite - Cold Saturated Soln. (KCl • MgCl ₂ • 6H ₂ O)	B	B	3	1**						
Cellulose					1	1				1
Chloracetic Acid	70	21	3	3	3	2	2	2	2	2
Chlorbenzol Conc. Pure Dry	70	21	1	1	2	2	2	2	2	2
Chloric Acid	70	21	3	3	3	3	3	3	3	3

Chemical	Temp		Stainless Steel		Mild Steel	Brass (80-20)	Bronze (Phos.)	Monel
	°F	°C	18-8	18-8 Mo.				
Chlorine Gas (Dry)	70	21	3	2	2	1	1	2
Chlorine Gas (Moist)	70	21	3	3	3	3	3	3
Chlorinated Water, Saturated			3**	2**	3			2
Chloroform	70	21	1	1	1	1	1	1
Chromic Acid 5% C.P.	70	21	1	1	3	3	3	3
Chromic Acid 10%	70	21	3	2	3	3	3	3
Chromic Acid 10% C.P.	B	B	3	2	3	3	3	3
Chromic Acid 50% C.P.	70	21	3	2	3	3	3	3
Chromic Acid 50% C.P.	B	B	3	3	3	3	3	3
Chromic Acid Commercial 50% (Cont. SO ₂)	70	21	3	3	3	3	3	3
Chromic Acid Commercial 50% (Cont. SO ₂)	B	B	3	3	3	3	3	3
Chromium Plating Bath	70	21	1	1	2			3
Cidar	70	21	1	1	3	1	1	1
Citric Acid, 5% Still	70-150	21-65	1	1	3	2	1	2
Citric Acid, 5% Still 15% Still	70	21	1	1	3	3	2	2
Citric Acid, 5% Still 15% or Concentrated	B	B	2	1	3	3	2	3
Coca-Cola Syrup® (Pure)	70	21	1	1	3			2
Coffee	B	B	1	1	3	1	1	1
Cooper Acetate (Sat. Sol.)	70	21	1	1	3			2
Copper Carbonate (Sat. Sol.) in 50% NH ₄ OH			1	1		3	3	
Copper Chloride, 1% Agitated	70	21	2**	1**	3	3	3	3
1% Agitated	158	70	3	3	3	3	3	3
1% Aerated	70	21	2**	1**	3	3	3	3
5% Agitated	70	21	3**	2**	3	3	3	3
5% Aerated	70	21	3**	3**	3	3	3	3
Copper Cyanide (Sat. Sol.)	B	B	1	1		3	3	2
Cooper Nitrate 1% Still, Agitated & Aerated	70	21	1	1	3	3	3	3
Cooper Nitrate 5% Still, Agitated & Aerated	70	21	1	1	3	3	3	3
Cooper Nitrate 50% Aqueous Solution	Hot	Hot	1	1	3	3	3	3
Copper Sulphate								
5% Agitated Still or Aerated	70	21	1	1	3	2	2	3
Saturated Solution	B	B	1	1	3	2	2	3
Creosote (Coal Tar)	Hot	Hot	1	1	2	1	1	2
Creosote Oil	Hot	Hot	1	1	2	2	2	2
Cyanogen Gas	70	21	1	1				-
Dichloroethane (Dry)	B	B	1	1	3	3	3	2
Dinitrochlorobenzene Melted & Solidified	70	21	1	1	3			-
Distillery Wort	70	21	1	1				-
Developing Solutions	70	21	1	1				-
Dyewood Liquer	70	21	1**	1	3			2
Epsom Salt (Magnesium Sulfate)	Hot & Cold	Hot & Cold	1	1	3	1	1	2
Ethers	70	21	1	1	2	1	1	2
Ethyl Acetate (Conc. Sol.)	70	21	1	1	2	1	1	2
Ethyl Chloride	70	21	1	1	2	2	2	1
Ethylene Chloride	70	21	1	1	2	2	2	1
Ethylene Glycol	70	21	1	1	2	1	1	1
Ferric Chloride 1% Solution Still	70	21	2**	1**	3	3	3	3
Ferric Chloride 1% Solution	B	B	3	3	3	3	3	3
Ferric Chloride 5% Solution, Agitated, Aerated	70	21	3	3	3	3	3	3
Ferric Hydroxide (Hydrated Iron Oxide)	70	21	1	1	3			2
Ferric Nitrate 1%-5% Quiescent or Agitated	70	21	1	1	3	3	3	3
Ferric Nitrate 1%-5% Aerated	70	21	1	1	3	3	3	3
Ferric Sulphate								
1%-5% Quiescent or Agitated	70	21	1**	1	3	3	3	3
1%-5% Aerated	70	21	1**	1	3	3	3	3
10%	B	B	1**	1	3	3	3	3
Ferrous Chloride Saturated Solution	70	21	3	1	3	2	2	-
Ferrous Sulphate Dilute Solution	70	21	1	1	3	2	2	3
Fluorine (Gas) Moist	70	21	3	3	3	3	3	3
Formaldehyde 40% Solution			1**	1**	2	1	1	1
Formic Acid, 5% Still	70	21	2	1	3	2	2	2
5% Still	150	65	2	1	3	2	2	3
Fruit Juices	70	21	1	1	3	2	2	2
Fuel Oil	Hot	Hot	1	1	2	1	1	2
Containing Sulphuric Acid			3	2		3	3	2
Furfural	70	21	1	1	2	1	1	2
Galic Acid, 5%	70-150	21-65	1	1	3			2
Saturated	212		1	1	3			2
Gasoline	70	21	1	1	2	1	1	1
Gelatin			1	1	3	1	1	1
Glue Dry	70	21	1	1	1	2	2	2
Solution - Acid	70-140		2**	1	2	3	3	2
Glycerine	70	21	1	1	2	1	1	1
Hydrochloric Acid All Concentrations	70	21	3	3	3	3	3	3
Hydrocyanic Acid	70	21	1	1	3	3	3	2
Hydrofluoric Acid	70	21	3	3	3	3	3	1
Hydrofluosilicic Acid	70	21	3	3	3	2	2	2
	70	21	1**	1	3	3	3	2
Hydrogen Peroxide	B	B	2**	1	3	3	3	2

Chemical	Temp		Stainless Steel		Mild Steel	Brass (80-20)	Bronze (Phos.)	Monel
	°F	°C	18-8	18-8 Mo.				
Hydrogen Sulphide (Dry)	70	21	1	1	2	1	1	3
Hydrogen Sulphide (Wet)	70	21	2***	1***	3	3	3	3
Hyposulphite Soda (Hypo)			1	1				-
Ink			70	2***	1	3	3	3
Iodine	70	21	3	3	3	3	3	3
Iodoform	70	21	1	1	3			2
Kerosene	70	21	1	1	2	1	1	2
Ketchup, Quiescent	70-150	21-65	1**	1	3			2
Lactic Acid, 1%	70	21	1	1	3	2	2	2
1%	B	B	1	1	3	3	3	2
5%	70	21	1	1	3	2	2	2
5%	150	65						
	B	B	2	1	3	3	3	2
10%	70	21	2	1	3	3	3	2
10%	150	65	3	2	3	3	3	2
	B	B						
Concentrated	70	21	2	1	3	2	2	2
Concentrated	B	B	3	2	3	3	3	2
Lard	70	21	1	1				1
Lead (Molten)	750		2	2		3	3	3
Lead Acetate 5%	B	B	1	1	3			2
Linseed Oil	70	21	1	1	2	2	2	1
Plus 3% H ₂ SO ₄	390		2	1	3	3	3	1
Magnesium Chloride 1% Quiescent	70	21	1**	1	3	2	2	1
Magnesium Chloride 1% Quiescent	Hot	Hot	3	2**	3	2	2	1
Magnesium Chloride 5% Quiescent	70	21	1**	1	3	2	2	1
Magnesium Chloride 5% Quiescent	Hot	Hot	3	2**	3	2	2	1
Magnesium Oxochloride	70	21	3	2**	3			-
Magnesium Sulphate	Hot & Cold	Hot & Cold	1	1	3	1	1	1
Malic Acid	Hot & Cold	Hot & Cold	2	1	3			2
Mash	Hot	Hot	1	1				2
Mayonnaise	70	21	1**	1	3			2
Mercury			1	1	1	3	3	3
Mercuric Chloride Dilute Sol.	70	21	3	3	3	3	3	3
Methanol (Methyl Alcohol)			1	1	2	1	1	1
Milk, Fresh or Sour	70	21	1	1	3	1	1	2
	B	B	1	1	3	1	1	2
Mixed Acids 53% H ₂ SO ₄ + 45% HNO ₃	Cold	Cold	1	1	3	3	3	3
Molasses			1	1	2	2	1	1
Muriatic Acid	70	21	3	3	3	3	3	2
Mustard	70	21	1**	1**	3			2
Naphtha, Crude	70	21	1	1	2	2	2	1
Naphtha, Pure	70	21	1	1	2	2	2	1
Naphthalene Sulfonic Acid	70	21	1	1	3			1
Nickel Chloride Solution	70	21	1**	1**	3	3	2	2
Nitrating Solution	Cold & Hot	Cold & Hot	2	2		3	2	3
Nickel Sulphate	Cold & Hot	Cold & Hot	1	1	3	3	1	1
Niter Cake	Fused		2	1	3			2
Nitric Acid 5% - 50% - 70%	B	B	1	1	3	3	3	3
Nitric Acid 65%	70	21	1	1	3	3	3	3
Nitric Acid 65%	B	B	2	2	3	3	3	3
Nitric Acid Concentrated	70	21	1	1	3	3	3	3
Nitric Acid Concentrated	B	B	3	3	3	3	3	3
Nitric Acid Fuming Concentrated	70-110		1	1	3	3	3	3
Nitric Acid Fuming Concentrated	B	B	3	3	3	3	3	3
Nitrous Acid 5%	70	21	1	1	3	3	3	3
Oils, Crude	Cold & Hot	Cold & Hot	1**	1**		2	2	1
Oils, Vegetable, Mineral	Cold & Hot	Cold & Hot	1***	1		2	2	1
Oleic Acid	70-400	21-204	1**	1	2	2	2	2
Oxalic Acid								
5%-10%	70 & B	21 & B	1	1	3	3	2	2
10%	B	B	3	3	3	3	2	2
25%-50%	B	B	3	3	3	3	2	1
Paraffine	Cold & Hot	Cold & Hot	1	1	2	1	1	1
Phenol (See Carboic Acid) Petroleum Ether			1	1	2			2

Chemical	Temp		Stainless Steel		Mild Steel	Brass (80-20)	Bronze (Phos.)	Monel
	°F	°C	18-8	18-8 Mo.				
Phosphoric Acid								
1%	70	21	1*	1*	3	3	3	2
1%	B	B	1	1	3	3	3	2
1%—45 lbs. Pressure	284		1	1	3	3	3	2
5% Quiescent, or Agitated	70	21	1	1	3	3	3	2
5% Aerated	70	21	1	1	3	3	3	2
10% Quiescent	70	21	3	1	3	3	3	2
10% Agitated or Aerated	70	21	3	2	3	3	3	2
10%—50%	B	B	1	1	3	3	3	3
80%	70	21	3	3	3	3	3	2
80%	230		3	3	3	3	3	3
85%	B	B	3	3	3	3	3	3
Picric Acid	70	21	1	1	3	3	3	3
Potassium Bichromate, 25%	70	21	1	1	3	3	3	2
25%	B	B	1	1	3	3	3	2
Potassium Bromide	70	21	2**	1**	3	2	2	2
Potassium Carbonate 1%	70	21	1	1	2	2	2	1
Potassium Carbonate	Hot	Hot	1	1	2	3	3	1
Potassium Chlorate Sat. at 212°	B	B	1	1	2	3	3	3
Potassium Chloride								
1% Quiescent	70	21	1**	1**	3	3	2	1
1% Agitated or Aerated	70	21	1	1	3	3	2	1
5% Quiescent	70	21	1	1	3	3	2	1
5% Agitated or Aerated	70	21	1	1	3	3	2	1
5%	B	B	1	1	3	3	2	1
Potassium Chromium Sulfate								
5%	70	21	1**	1	3	3	2	-
Sp. G. 1.6	B	B	3	3	3	3	3	-
Potassium Cyanide	70	21	1	1	2	3	3	2
Potassium Ferricyanide, 5%-25%	70	21	1	1	3			2
25%	B	B	1	1	3			2
Potassium Ferricyanide, 5%	70	21	1	1	3			2
Potassium Hydroxide, 5%	70	21	1	1	2†	3	2	1
27%	B	B	1	1	2†	3	2	1
50%	B	B	2	1	3	3	2	1
Potassium Hypochlorite	70	21	2	2	3	3	3	3
Potassium Nitrate								
1%-5% Still or Agitated	70	21	1	1	3	2	2	1
1%-5% Aerated	70	21	1	1	3	2	2	1
50%	70	21	1	1	3	2	2	1
50%	B	B	1	1	3			1
Molten	1022		1	1	3			-
Potassium Oxalate			1	1				-
Potassium Permanganate, 5%	70	21	1	1	2			3
Potassium Sulphate								
1%-5% Still or Agitated	70	21	1	1	2	2	1	2
1%-5% Aerated	70	21	1	1	2	2	1	2
Potassium Sulphide (Salt)			1	1	3			-
Pyrogallic Acid			1	1	2			-
Quinine Bisulphate (Dry)			2	1	3			-
Quinine Sulphate (Dry)			1	1	3	2	2	2
Rosin	Molten		1	1	3	1	1	1
Sea Water	70	21	1**	1**	3	2	2	1
Sewage			1***	1***		1	1	1
Silver Bromide			2**	1**	3	3	3	-
Silver Chloride			3	3	3	3	3	3
Silver Nitrate			1	1	3	3	3	3
Soap	70	21	1	1	2	1	1	1
Sodium Acetate (Moist)			1**	1	3			2
Sodium Bicarbonate All Concentrations	70	21	1	1	3	2	2	1
Sodium Bicarbonate 5% Still	150	65	1	1	3	2	2	1
Sodium Bisulphate, Solution	70	21	1***	1***	3	3	2	2
Saturated Solution	70	21	3	3	3	3	2	2
2 g. + 1 g. H ₂ SO ₄ , liter	68		3	1***	3	3	2	2
Sodium Carbonate, 5%	70-150	21-65	1	1	2	2	2	1
5%-50%	B	B	1	1	2	2	2	1
Molten	1650		3	3	3	3	3	1
Sodium Chloride, 5% Still	70-150	21-65	1**	1	3	3	2	1
20% Aerated	70	21	1**	1	3	3	2	1
Saturated	70	21	1**	1	3	3	2	1
Saturated	B	B	2**	1	3	3	2	1
Sodium Cyanide	70	21	1	1	2	3	3	-

Chemical	Temp		Stainless Steel		Mild Steel	Brass (80-20)	Bronze (Phos.)	Monel
	°F	°C	18-8	18-8 Mo.				
Sodium Fluoride, 5% Solution	70	21	2**	1**	3	1	1	1
Sodium Hydroxide	70	21	1	1	2	3	2	1
Sodium Hypochlorite, 5% Still			2**	1**	3	3	2	3
Sodium Hyposulfite	70	21	1***	1	3			1
Sodium Nitrate	Fused		1	1	2	1	1	2
Sodium, Perchlorate, 10%	70	21	1	1				-
	B	B	1	1				-
Sodium Phosphate	70	21	1	1	2	2	2	2
Sodium Sulphate, 5% Still	70	21	1	1	3	1	1	1
All Concentrations	70	21	1	1	3	1	1	1
Sodium Sulphide, Saturated			2**	1	3	3	3	2
Sodium Sulphite, 5%	70	21	1	1	3	3	2	2
10%	150	65	1	1	3	3	2	2
Sodium Thiosulphate								
Saturated Solution	70	21	1	1***	3	3	3	1
Acid Fixing Bath (Hypo)	70	21	1	1	3	3	3	2
25% Solution	70	21	1	1***	3	3	3	2
	& B	& B	1	1***	3	3	3	2
Stannic Chloride Solution Sp. G. 1.21	70	21	3	3	3	3	3	3
	& B	& B	3	3	3	3	3	3
Stannous Chloride, Saturated			3	1	3			3
Steam			1	1	3	2	1	1
Stearic Acid	70	21	1	1	3	3	2	2
Starch, Aqueous Solution			1	1				2
Strontium Hydroxide			1	1				-
Strontium Nitrate Solution	Hot	Hot	1	1	3			2
Sulphur, Moist	70	21	2**	1**	3	3	3	2
Molten	266		1	1	3	3	3	1
Molten	833		3	3	3	3	3	3
Sulphur Chloride (Dry)			3	3	3	1	1	2
Sulphur Dioxide Gas (Moist)	70	21	2	1	3	2	2	3
Sulphur Dioxide Gas (Dry)	575		1	1	3	1	1	2
Sulphuric Acid								
5%-10%	70	21	3	2	3	3	2	3
5%-10%	B	B	3	3	3	3	3	3
50%	70	21	3	3	3	3	3	3
50%	B	B	3	3	3	3	3	3
Concentrated	70	21	1	1	3	3	2	3
Concentrated	B	B	3	3	3	3	2	3
Concentrated	300		3	3	3	3	2	3
Fuming	70	21	3	2	3	3	2	3
Sulphurous Acid, Saturated	70	21	3	2	3	3	2	3
Saturated — 60 lb. Pressure	250		3	2	3	3	2	3
Saturated — 70-125 lb. Pressure	310		3	2	3	3	2	3
150 lbs. Pressure	375		3	2	3	3	2	3
Sulphurous Spray	70	21	3	3	3	3	3	3
	70	21	1	1	3	2	1	3
Tannic Acid	150	65	1	1		2	1	3
Tanning Liquor	70	21	1	1				1
Tar			1	1	2	1	1	1
Tartaric Acid, 10%	70	21	1	1	3	2	1	2
10%-50%	B	B	2	1	3	2	1	2
Tin	Molten		3	3	3	3	3	-
Trichloroacetic Acid	70	21	3	3	3	3	2	3
Trichlorethylene (Dry)	70	21	1**	1	3	1	1	1
Trichlorethylene (Moist)						2	2	-
Varnish	70	21	1	1	2	1	1	1
Vegetable Juices			1	1	2	3	2	2
Vinegar Fumes			2	1	3	3	2	3
Vinegar, Still, Agitated or Aerated	70	21	1	1	3	3	2	3
Water			1	1	2	1	1	1
Whiskey			1	1	3	2	1	1
Wine — All Phases of Processing and Storing	75		1	1	3	3	3	2
Yeast			1	1		3	3	1
Zinc	Molten		3	3	3	3	3	3
Zinc Chloride, 5% Still	70	21	1**	1**	3	3	3	2
	B	B	2**	2**	3	3	3	2
Zinc Cyanide, Moist	70	21	1	1	3			-
Zinc Nitrate, Solution	Hot	Hot	1	1	3			-
Zinc Sulphate, 5%	70	21	1	1	3	3	2	2
25%	B	B	1	1	3	3	2	2
Saturated	70	21	1	1	3	3	2	2

† Mild steel severely stressed subject to caustic embrittlement

Motion Selection Factors

STAMPED Motion

Motion Types

Most industrial applications can be reduced to one of five classes of motion: Angular, Axial, Offset, Radial; or Random.

Angular

Motion that occurs when one end of a hose assembly is deflected in a simple bend with the ends not remaining parallel. Angular motion may be incorporated in an installation to accommodate misalignment and vibration only, but must not be used to accommodate expansion that would result in unloading the braid.

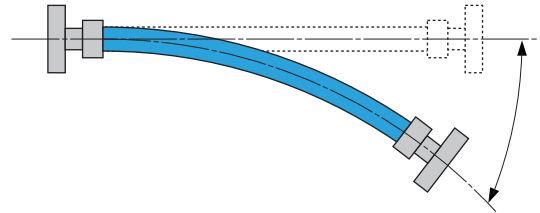

Axial

This type of motion occurs when one end of a hose assembly is deflected along its longitudinal axis. Axial motion is applicable to annular corrugated, unbraided flexible hose only. Neither helical hose nor braided hose should be used in axial motion applications.

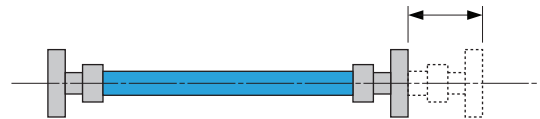

Offset

Motion that occurs when one end of the hose assembly is deflected in a plane perpendicular to the longitudinal axis with the end remaining parallel. Offset is measured in inches of displacement of the free end centerline from the fixed end centerline. In offset motion applications, the offset should never be greater than one-fourth (25%) of the minimum centerline bend radius.

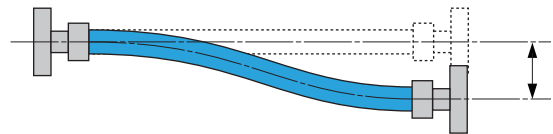

Radial

This type of motion occurs when the centerline of a hose assembly is bent in a circular arc. In industrial applications, radial motion is most commonly found in traveling loops.

Class "A" Traveling Loops

For Maximum Vertical Travel

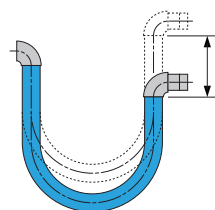

For Maximum Horizontal Travel

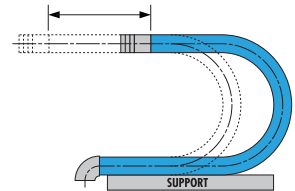

Class "B" Traveling Loops

For Short Horizontal Travel

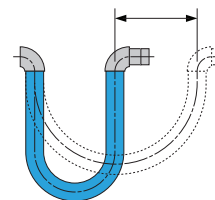

For Short Vertical Travel

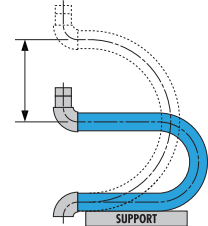

Random

Non-predictable motion that occurs from manual handling of a assembly. Loading and unloading hose would generally fall into this category. Abusive handling of hose is an important factor to consider in applications involving random motions. The use of an interlocked (RT-6) guard over the corrugated hose is recommended to protect the hose assembly from rough handling and "over-bending" adjacent to the fittings.

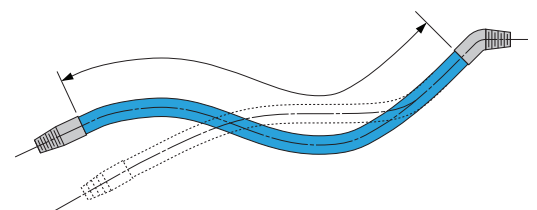

Motion Selection Factors (continued)

STAMPED Motion

Motion Frequency

The frequency of a particular class of motion to which a flexible metal hose may be subjected by repeated flexing or bending. The frequency of motion may be divided into three basic categories: namely vibration, dynamic, and continuous. The minimum live length required for these motion categories may be selected as follows:

Vibration:

For the normal vibration encountered in industrial applications, such as pump and compressor discharge lines and engine exhaust installations, the hose live lengths should be taken from the Minimum Live Length For Vibration column on Technical Data Pages.

Normal vibration is shown as the unshaded area of the chart below. If the expected combination of double amplitude (total motion excursion) and frequency falls into the shaded area, consult United Flexible Engineering Group.

Caution: Avoid hose resonance. If resonance is anticipated, consult United Flexible Engineering Group.

Dynamic Motion:

Motion that occurs on a regular or irregular basis normally the result of thermal expansion and contraction or other noncontinuous actions.

The dynamic flexing bend radius shown on Hose Technical Data Pages shall be used in the formulas for angular, radial and offset motion when determining hose live length for dynamic motion.

Continuous Motion:

Motion that occurs on a regular cyclic basis normally at a slow cyclic rate and constant travel. For Continuous Lateral Offset Motion double the minimum centerline bend radius for Dynamic Flexing shown on Hose Technical Data Pages.

Static Bend:

The minimum centerline bend radius to which a flexible metal hose may be bent for installation. No further motion is to be imposed other than normal vibration.

Cycle Life

The cycle life expectancy of a metal hose is affected by various factors such as: operating pressure, operating temperature, materials, bend radius (the movement per corrugation due to the flexure), the thickness of the corrugation. Any change in one of these factors will result in a change in the cycle life of a metal hose assembly.

The cycle life of a metal hose assembly is proportional to the sum of the pressure stress range and deflection stress range. The life expectancy can be defined as the total number of completed cycles which can be expected from the metal hose assembly based on S/N curves and data tabulated from tests performed under simulated operating conditions. A cycle is defined as one complete movement from the initial position in the system to some operating point and returning to the original position.

This information should be used as a guide only. We cannot predict every variable which might be encountered in every application nor any misapplication, mechanical damage, and/or any uncontrollable situation.

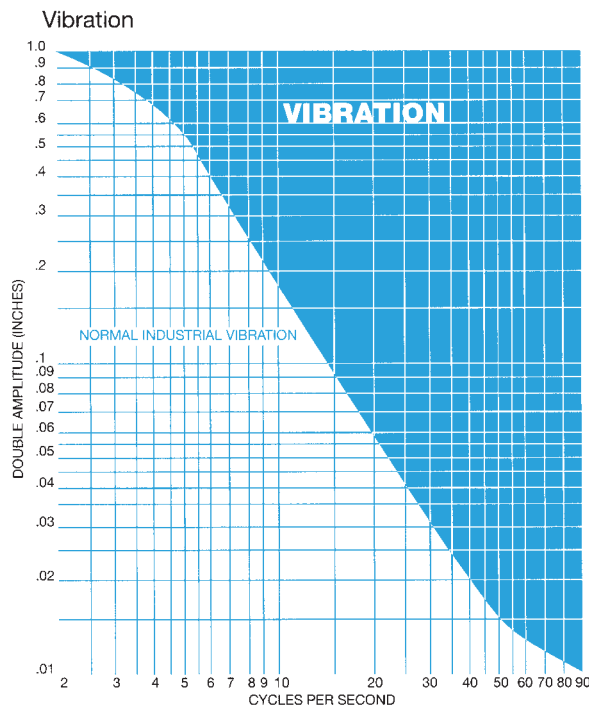

Pressure Selection Factors

STAMPED Pressure

Pressure Ratings

United Flexible pressure ratings are in accordance with industry-wide good practice and are consistent with the requirements of :

- » USA Standard Code for Pressure Piping and the ASME Boiler and Pressure Vessel Code, Sec. VIII.
- » Pressure Equipment Directive (PED) 2014/68/EU Module H

Maximum Working Pressure

Maximum operating pressure to which the hose should be subjected. It is established at 25% of the Nominal Design Burst Pressure. The hose may be deflected within the specified bend radius range.

Maximum Proof Pressure

Maximum test pressure to which the hose should be subject. It is established at 150% of the Maximum Working Pressure with the hose installed straight. No harmful deformation shall occur.

Hydrostatic field tests of hose assemblies installed in varying degrees of radial bend or parallel offset should be limited to 120% of the maximum rated working pressure at 70°F (21.1°C), or 150% of the actual operating pressure, whichever is lower.

Nominal Design Burst Pressure

The pressure at which the hose can be expected to rupture, based on the minimum annealed ultimate tensile strength of the braid wire and corrugated hose alloys at 70°F (21.1°C) and the hose installed straight.

Pulsating or Shock Pressures

When pulsating, surge or shock pressures exists, such as occur due to fast closing valves, the peak pressure shall not exceed 50% of the Maximum Working Pressure. Installation shall be such that there is no initial slack in the braid when the pressure pulse, surge or shock occurs.

Pressure Relative To Unbraided Hose

At Maximum Working Pressure, 1 to 2½% elastic elongation will occur in unbraided hose assemblies. To avoid squirm, unbraided hose should be unrestrained at one end, or installed in such a manner as to allow free axial expansion due to pressure, as in a 180° loop.

Pressure Relative To Braided Hose

Whenever appreciable internal pressure is applied to a corrugated metal hose, it will elongate unless restrained. Generally this restraint is provided by a wire braid sheath over the hose. The braid has little effect on bending or flexibility of the hose. However, in extremely short lengths of braided and pressurized hose, additional bending forces are required because of braid friction.

Where the strength of the braid sheath is the limiting factor, additional working pressure may be gained by using a heavier than standard single braid, or two or more braids. However, when the hoop rupture strength of the corrugated hose is the limiting factor, no additional pressure resistance is gained with additional braids.

Contact United Flexible Engineering Group for braid/hose design assistance to determine maximum pressure ratings at lowest total cost for an application.

Wellhead Relief - When a major oil company needed a wellhead relief valve system for gas wells, nothing in the market met its spec. For a flexible fireproof hose to aid in vibration absorption and pipe alignment at extremely high pressures (1450 psi), they turned to us. We custom designed and built an 1800-psi Inconel 3" hose, which far exceeded requirements.

End Selection Factors

STAMP Ends

Welded Pipe End with 37½ Degree Bevel

Size Availability: 1/8" diameter to 12" diameter

Material Availability: Carbon Steel, T304 Stainless Steel, T304L Stainless Steel, T321 Stainless Steel, T316 Stainless Steel, T316L Stainless Steel

Schedule Availability: 5, 10, 40, 80, 160, XX

Pipe End

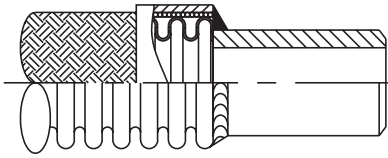

Concentric Reducer

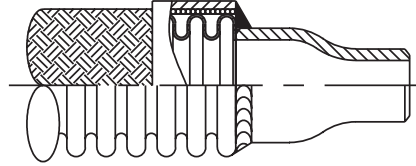

Long Radius 90 Degree Elbow

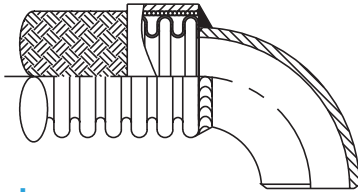

Long/Short Radius 45° Elbows

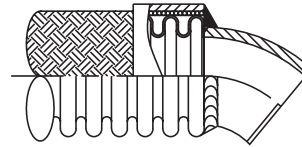

Flanged Ends

Size Availability: 1/2" diameter to 12" diameter

Material Availability: Carbon Steel, T304 Stainless Steel, T304L Stainless Steel, T321 Stainless Steel, T316 Stainless Steel, T316L Stainless Steel

Schedule Availability: 5, 10, 40, 80, 160, XX

ANSI Class Ratings: 150, 300, 600, 900, 1500, 2500

EN 1092-1 Ratings: PN 6, 10, 16, 25, 40, 63, 100, 160, 250, 320, 400

Weld Plate

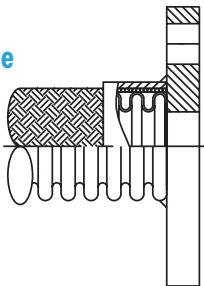

Raised Face Slip-On (RFSO)

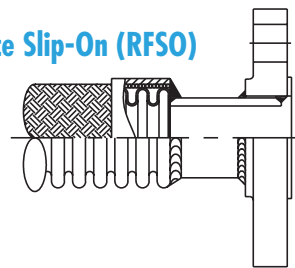

Raised Face Weldneck

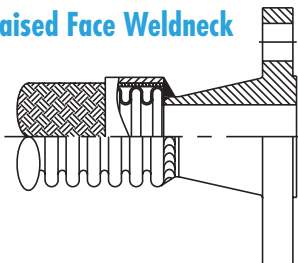

Floating Lap Joint w/Stub End

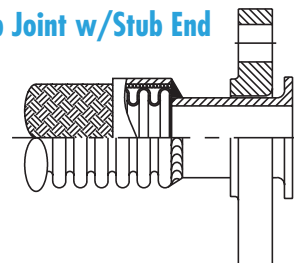

Note: Not all sizes and schedules are available in combination - consult factory for details

End Selection Factors (continued)

STAMP Ends

Threaded Ends

Size Availability: 1/4" diameter to 12" diameter

Material Availability: Carbon Steel, T304 Stainless Steel, T304L Stainless Steel, T321 Stainless Steel, T316 Stainless Steel, T316L Stainless Steel

Schedule Availability: 5, 10, 40, 80, 160, XX

NPT/BSPT/BSPP Male Nipple

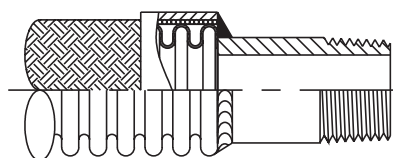

NPT/BSPT/BSPP Male w/Hex Nut

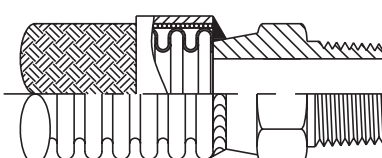

Female NPT/BSPT Half Coupling

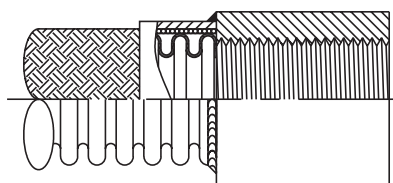

BSPP Swivel

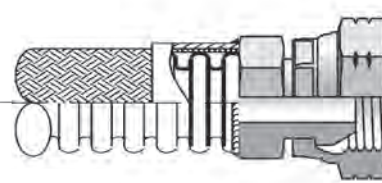

JIC Swivel Female

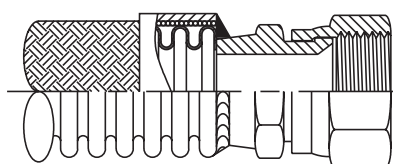

Welded Female Union

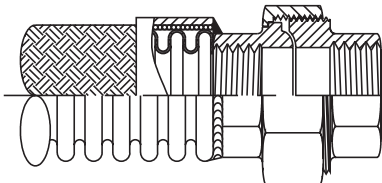

Note: Not all sizes and schedules are available in combination - consult factory for details

End Selection Factors (continued)

STAMP Ends

Quick Disconnects

Size Availability: 1/2" diameter to 8" diameter

Material Availability: Carbon Steel, T316 Stainless Steel, Hastelloy®

Female Part "D" Coupler

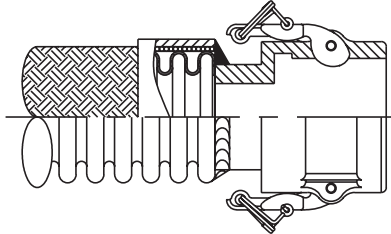

Male Part "A" Camlock

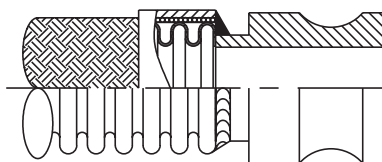

Tube Ends

Size Availability: 1/4" diameter to 4" diameter

Material Availability: Carbon Steel, T304 Stainless Steel, T304L Stainless Steel, T321 Stainless Steel, T316 Stainless Steel, T316L Stainless Steel, Copper

Tube Ends

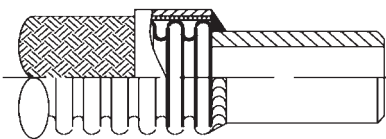

Distance Selection Factors (Live Length and Overall Length)

STAMPE Distance

After the hose is selected for the application, the live length and overall length of the assembly must be determined to complete the design. The live length is the flexible portion of an assembly and can be determined for the class of motion from the diagrams and for vibration.

After the live length has been determined, the overall length is calculated by adding the dimensions for the end fittings. Refer to factory for fitting lengths as standard and special lengths can be offered.

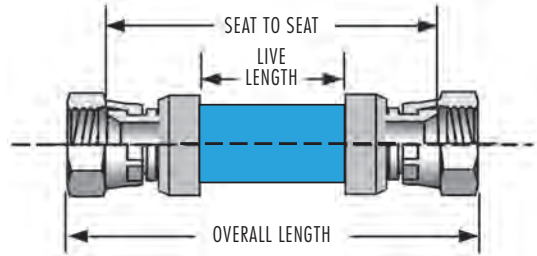

Angular Motion

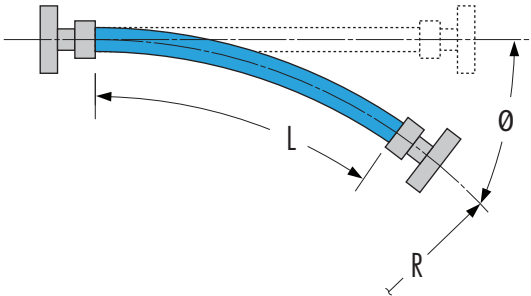

L = Live Length (in.)
 R = Centerline bend radius (in.)
 Ø = Angle of Bend (degrees)
 $\pi = 3.1416$

$$L = \frac{\pi R \theta}{180}$$

Radial Motion

Class "A" Traveling Loops

For Maximum Vertical Travel

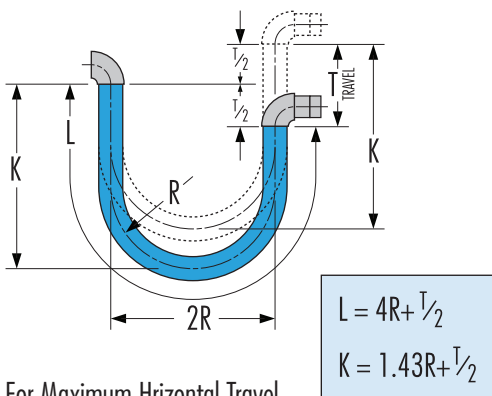

$$L = 4R + \frac{T}{2}$$

$$K = 1.43R + \frac{T}{2}$$

For Maximum Horizontal Travel

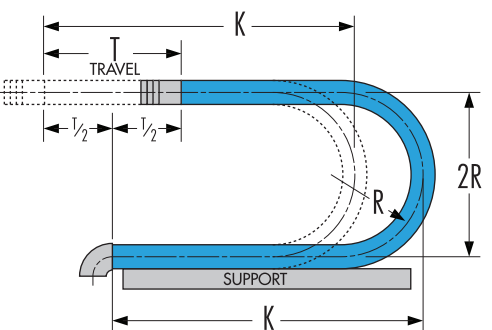

Class "B" Traveling Loops

For Short Vertical Travel

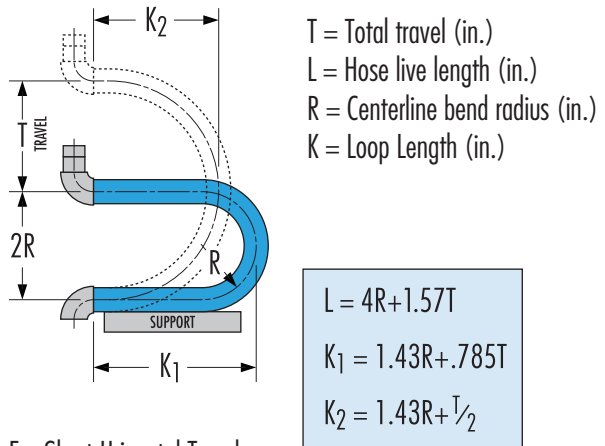

$$L = 4R + 1.57T$$

$$K_1 = 1.43R + .785T$$

$$K_2 = 1.43R + \frac{T}{2}$$

For Short Horizontal Travel

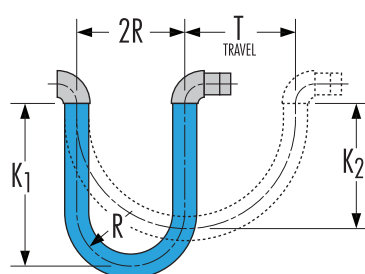

NOTE:
 In loop installations both connections and travel should be in same plane as bend.

Distance Selection Factors (continued)

STAMPE Distance

Offset Motion

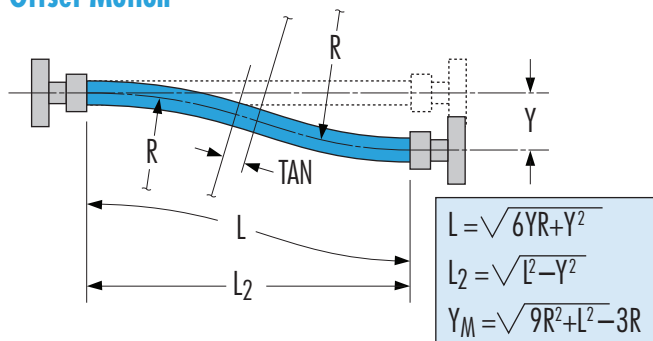

- L = Hose live length (inches)
- L2 = Projected linear length at offset (inches)
- R = Centerline bend radius (inches)
- Y = Centerline offset, Motion (inches)
- Y_M = Centerline maximum offset for a given L and R (inches)

NOTE: Where Offset Motion "Y" occurs both sides of Centerline the Hose Live Length should be based on Total Travel or 2 times Y.

Important Note:

The values shown below are minimum live lengths for most centerline bend radii and total offset travel combinations. If the exact radius or travel are not shown on the chart, then the next larger value may be used or use the lateral offset formula. The values as shown in the shaded portion are applicable to static bends only. The offset motion should never be greater than 1/4 (25%) of the centerline bend radius.

Chart for Live Length of Hose in Offset

Maximum Distance from Centerline

	1/8"	1/4"	3/8"	1/2"	3/4"	1"	1 1/2"	2"	3"	4"	5"	6"	8"	10"
2	1 1/4	1 3/4	2 1/4	2 1/2	3 1/4	3 3/4	4 1/4	5 1/4	6 3/4	8	9 1/4	10 1/2	11 3/4	15
4	1 3/4	2 1/2	3	3 1/2	4 1/2	5	6 1/4	7 1/4	9	10 3/4	12	13 1/2	16	18 1/2
6	2 1/4	3 1/4	3 3/4	4 1/4	5 1/4	6 1/4	7 1/2	8 3/4	10 3/4	12 3/4	14 1/4	16	19	21 1/2
8	2 1/2	3 1/2	4 1/4	5	6	7	8 3/4	10	12 1/2	14 1/2	16 1/4	18	21 1/4	24 1/4
10	2 3/4	4	4 3/4	5 1/2	6 3/4	8	9 3/4	11 1/4	13 3/4	16	18	20	23 1/2	26 1/2
12	3	4 1/4	5 1/4	6	7 1/2	8 1/2	10 1/2	12 1/4	15	17 1/2	19 1/2	21 1/2	25 1/2	28 3/4
14	3 1/4	4 3/4	5 3/4	6 1/2	8	9 1/4	11 1/4	13 1/4	16 1/4	18 3/4	21	23 1/2	27 1/4	30 3/4
16	3 1/2	5	6	7	8 1/2	10	12 1/4	14	17 1/4	20	22 1/2	25	29	32 3/4
18	3 3/4	5 1/4	6 1/2	7 1/2	9	10 1/2	13	15	18 1/4	21 1/4	24	26	30 1/2	34
20	4	5 1/2	6 3/4	7 3/4	9 1/2	11	13 1/2	15 3/4	19 1/4	22 1/2	25	27 1/2	32 1/4	36 1/4
25	4 1/2	6 1/4	7 1/2	8 3/4	10 3/4	12 1/4	15	17 1/2	21 1/2	25	28	30 1/2	35 3/4	40
30	4 3/4	6 3/4	8 1/4	9 1/2	11 3/4	13 1/2	16 1/2	19	23 1/2	27 1/4	30 1/2	33 1/2	39	43 3/4
35	5 1/4	7 1/4	9	10 1/4	12 1/2	14 1/2	18	20 3/4	26 1/4	29 1/2	32 3/4	36	42	47
40	5 1/2	7 3/4	9 1/2	11	13 1/2	15 1/2	19	22	27	31 1/4	35	38 1/2	44 3/4	50
45	6	8 1/4	10	11 3/4	14 1/4	16 1/2	20 3/4	23 1/2	28 1/2	33 1/4	37	41	47 1/2	53
50	6 1/4	8 3/4	10 3/4	12 1/4	15	17 1/2	21 1/4	24 1/2	30	35	39	43	50	56
60	6 3/4	9 1/2	11 3/4	13 1/2	16 1/2	19	23 1/4	27	33	38 1/4	43	47	54 1/4	61
70	7 1/4	10 1/4	12 3/4	14 3/4	17 3/4	20 1/2	25 1/4	29	35 1/2	41 1/2	46	51	58 3/4	65 3/4
80	7 3/4	11	13 1/2	15 1/2	19	22	27	31	38	44	49 1/2	54	62 3/4	70
90	8 1/4	11 3/4	14 1/4	16 1/2	20 1/4	23 1/2	28 1/2	33	40 1/2	46 3/4	52	57 1/4	66 1/4	74 1/4
100	8 3/4	12 1/4	15	17 1/2	21 1/4	24 1/2	30	35	42 1/2	49 1/4	55	60 1/2	69 3/4	78 1/4
110	9 1/4	13	15 3/4	18 3/4	22 1/2	25 3/4	31 3/4	36 1/2	44 3/4	51 1/2	58	63 1/4	73 1/4	82
120	9 1/2	13 1/2	16 1/2	19	23 1/4	27	33	38 1/4	46 3/4	54	60 1/2	66	76 1/2	85 1/2
130	10	14	17 1/4	20	24 1/4	28	34 3/4	39 3/4	48 1/2	56	62 3/4	68 3/4	79 1/2	89

Engineering Design Services



We Can Help!

In addition to our own products and solutions, we also offer our customers development services covering the entire product development process. We support you from the early phases when developing concepts and prototypes or during the technical engineering and calculation phases of series development.

As an engineering partner we have extensive experience with solving demanding tasks in such a way that the results become an optimal part of the overall system and function reliably

Calculations

Experience to calculate and determine requirements for severe applications such as: high pressure, high temperature, vibration, corrosive environments.

Drawings

Able to provide advanced CAD component and assembly drawings

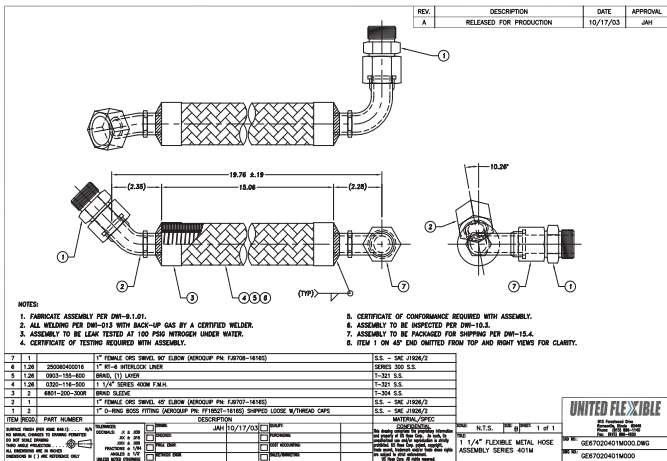
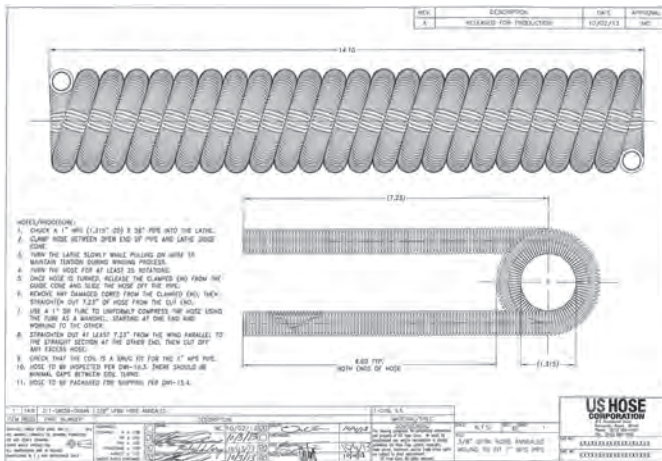

3D Models/Finite Element Analysis

Able to provide advanced 3D CAD component and assembly drawings and apply advance analysis techniques.

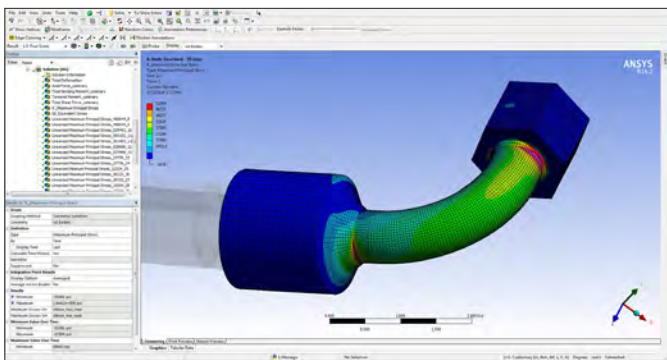
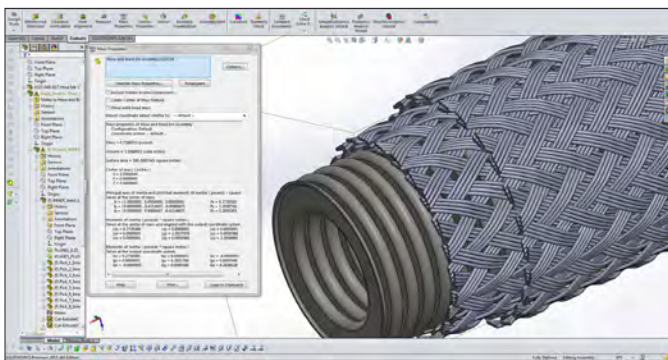

Special Assemblies

In addition to our standard product lines, United Flexible offers a wide array of specialty assemblies to satisfy some of the most demanding applications.

Vacuum/Steam Jacketed

Jacketed assemblies are multi-layer assemblies with an inner hose bore surrounded by a secondary layer providing an atmospheric "jacket" around the inner hose. This jacket allows for a heating, cooling or a vacuum thermal barrier to be applied to the media inside the assembly with out contamination or mixing of media.

Coal Injection

Eliminate problems with the United Flexible Coal Injection assembly designed for both pulverized injection and/or heavy duty coal injection application.

1. Non-flammable all metal construction.
2. Designed to withstand erosion from coal abrasion.
3. Engineered to significantly reduce pressure drop.
4. Factory-built by ASME certified welders in an ISO 9001 Certified facility.
5. Engineered to increase performance life.
6. Quick disconnect fittings allow rapid change over to alternate hydrocarbons.

United Flexible's Coal Injection Assembly solves problems such as . . .

1. Rubber hose catching on fire.
2. Hose failure from erosion due to abrasive action of coal.
3. Clogging of hose from restrictions in hose diameter.
4. Short life span with frequent replacements.
5. Unreliable attachment of fittings to hose.
6. A need for quick disconnect fittings to switch to an alternate fuel; natural gas or oil.

Metal PTFE Lined (MTLC)

MTLC is a high quality engineered flexible metal braided hose with a smooth inner liner of extruded PTFE. The assembly is reinforced with a layer of stainless steel braid. A smooth liner of PTFE is locked in place and flared over the flange faces. The PTFE liner is stationary and will not move once locked into position. Special vent holes in the ends prevent gas build-up between the layers.

Oxygen Lance

United Flexible has been manufacturing and supplying metal corrugated stainless steel hose for handling oxygen for decades. United Flexible's all metal construction is safe, non-combustible, absolutely pressure and vacuum tight, and wear resistant. Our lance assemblies are a practical answer to the many uncertainties of rubber or packed interlock lance hoses.

Eleven good reasons for you to specify a United Flexible Stainless Steel Lance Hose.

1. 100 percent metal. . .withstands temperatures up to 1500 degrees Fahrenheit without deterioration.
2. Metallic Construction. . .superior fire, flame, and char-proof characteristics. Will not catastrophically fail in a major fire.
3. Complete Oxygen Compatibility. . .assures flow of pure oxygen.
4. Zero Leakage. . .saves oxygen, helps assure steel's uniformity, adds extra safety dimension.
5. Fittings Welded To Hose. . .optimum protection against breakage.
6. More flexible than Rubber. . .longer cycle life.
7. Weights Less Than rubber. . .easier handling, easier to install.
8. Double Braiding, Double Hose Layer. . .optimum operation, safety, and performance.
9. Doesn't Flatten In Bending. . .more uniform oxygen flow.
10. No Age Hardening. . .no shelf life limitations.
11. United Flexible Is The World Leader In Developing Hose For Steel Making Applications. . .And Has Been Since 1902.

Annular Hose
Construction

One Braid Shown

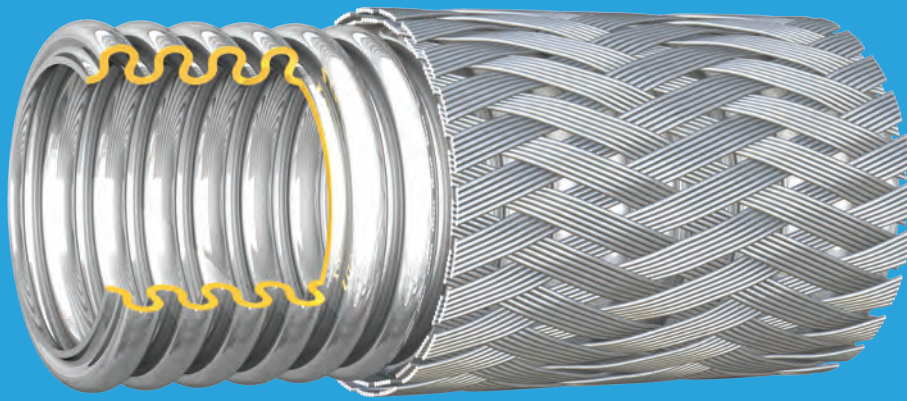

Metal Hose Standard Product Lines

460/860 Series

Standard pressure helical hose series suitable for full vacuum up to 2240 psig (154 bar), depending on size and braid construction. The 460 product line is comprised of T321 stainless steel and the 860 comprised of 316L stainless steel for temperature service from cryogenic service up to 1250°F (677°C). Sizes range between ¼" (4mm) up to 1½" (36mm) nominal diameter and is available as an unbraided (460/860) hose or as a direct braided single (461/861) or double (462/862) layer hose.

AFBX Series (formally USBX)

Standard pressure annular hose series suitable for full vacuum up to 1825 psig (126 bar), depending on size and braid construction. The AFBX product line is comprised of T321 stainless steel or 316L stainless steel for temperature service from cryogenic service up to 1250°F (677°C). Sizes range between ¼" (4mm) up to 2" (50mm) nominal diameter and is available as an unbraided (AFBX0) hose or as a direct braided single (AFBX1) or double (AFBX2) layer hose.

AFCX Series (formally USCX)

Standard pressure annular hose series suitable for full vacuum up to 1825 psig (126 bar), depending on size and braid construction. The AFBX product line is comprised of T321 stainless steel or 316L stainless steel for temperature service from cryogenic service up to 1250°F (677°C). Sizes range between ¼" (4mm) up to 2" (50mm) nominal diameter and is available as an unbraided (AFCX0) hose or as a direct braided single (AFCX1) layer hose.

UFBX Series (large bore formally 480/880)

Standard pressure annular hose series suitable for full vacuum up to 3190 psig (220 bar), depending on size and braid construction. The UFBX product line is comprised of T321 stainless steel or 316L stainless steel for temperature service from cryogenic service up to 1250°F (677°C). Sizes range between ¼" (4mm) up to 12" (300mm) nominal diameter and is available as an unbraided (UFBX0) hose or as a direct braided single (UFBX1) or double (UFBX2) layer hose. Versions available certified to ISO 10380.

400M/400H Series

Standard pressure heavy wall annular hose series suitable for full vacuum up to 4500 psig (310 bar), depending on size and braid construction. The 400M product line is comprised of T321 stainless steel and the 400H is comprised of 316L stainless steel for temperature service from cryogenic service up to 1500°F (815°C). Sizes range between ¼" (4mm) up to 12" (300mm) nominal diameter and is available as an unbraided (400M/400H) hose or as a direct braided single (401M/401H) or double (402M/402H) layer hose.

**Maximum Pressure depending on size and braid configuration*

Don't see what you need? Let our Engineering Department design a custom hose for your application!

Need Bigger Hose?
Larger Sizes Available Upon Request!!!

Metal Hose Standard Product Lines (continued)

High Pressure Hoses

UFC Series

High pressure super flexible annular hose series suitable for full vacuum up to 4424 psig (305 bar), depending on size and braid construction. The UFC product line is comprised of T321 stainless steel or 316L stainless steel for temperature service from cryogenic service up to 1250°F (677°C). Sizes range between ¼" (4mm) up to 4" (100mm) nominal diameter and is available as an unbraided (UFC0) hose or as a direct braided single (UFC1) or double (UFC2) layer hose.

400X Series

High pressure annular hose series suitable for full vacuum up to 5300 psig (365 bar), depending on size and braid construction. The 400x product line is comprised of heavy weight 316L stainless steel for temperature service from cryogenic service up to 1500°F (815°C). Sizes range between ¼" (4mm) up to 4" (100mm) nominal diameter and is available as a direct braided double (402X), triple (403X) or quad (404X) layered hose.

Ultra-High Pressure Hoses

RF67 Series

Ultra-high pressure helical hose series suitable for full vacuum up to 12000 psig (827 bar), depending on size and braid construction. The RF67 product line is comprised of heavy weight seamless 321 stainless steel for temperature service from cryogenic service up to 1500°F (815°C). Sizes range between ¼" (4mm) up to 3" (80mm) nominal diameter and is a multiple braided triple layered hose.

Special Alloy Hoses

A400 Series

Standard pressure annular exotic hose series suitable for full vacuum up to 3025 psig (208 bar), depending on size and braid construction. The A400 product line is comprised of Monel® 400 alloy for temperature service from cryogenic service up to 800°F (427°C). Sizes range between ¼" (4mm) up to 2" (50mm) nominal diameter and is available as an unbraided (A400) hose or as a direct braided single (A400-1) or double (A400-2) layer hose.

A625 Series

Standard pressure annular exotic hose series suitable for full vacuum up to 2660 psig (183 bar), depending on size and braid construction. The A625 product line is comprised of Inconel® 625 alloy for temperature service from cryogenic service up to 1800°F (982°C). Sizes range between ¼" (4mm) up to 12" (300mm) nominal diameter and is available as an unbraided (A625) hose or as a direct braided single (A625-1) or double (A625-2) layer hose.

A276 Series

Standard pressure annular exotic hose series suitable for full vacuum up to 1550 psig (106 bar), depending on size and braid construction. The A276 product line is comprised of Hastelloy® C276 alloy for temperature service from cryogenic service up to 1500°F (815°C). Sizes range between ¼" (4mm) up to 12" (300mm)

**Maximum Pressure depending on size and braid configuration*

Marine Application in UK needed a subsea hose (under great external pressure) to transport supersaturated sodium chloride which stainless steel could not handle. No one manufactured a solution that would fit that application. Our solution involved manufacturing a stripwound liner in Inconel -- still a unique solution for undersea transport.

1/4" (6mm) Metal Hose Pressure Ratings

T-321 & T-316L STAINLESS STEEL									
Hose Type	Hose Alloy	Braid		Full Vacuum to Maximum Pressure (at 70° F/21°C)					
				Working		Test		Burst	
		Layers	Alloy	psi	bar	psi	bar	psi	bar
460 / 860	T-321/T-316L	-	-	75	5.2	110	7.6	-	-
UFBX0	T-321	-	-	145	10.0	218	15.0	-	-
UFBX0	T-316L	-	-	145	10.0	218	15.0	-	-
AFBX0	T-321/T-316	-	-	145	10.0	218	15.0	-	-
AFCX0	T-321/T-316L	-	-	145	10.0	218	15.0	-	-
UFC0	T-321	-	-	145	10.0	218	15.0	-	-
UFC0	T-316	-	-	145	10.0	218	15.0	-	-
400M	T-321	-	-	200	13.8	300	20.7	-	-
400H	T-316L	-	-	265	18.3	400	27.6	-	-
AFBX1	T-321/T-316	1	300 Series	1825	125.8	2738	188.8	7300	503.3
AFCX1	T-321/T-316L	1	300 Series	1825	125.8	2738	188.8	7300	503.3
461 / 861	T-321/T-316L	1	300 Series	2240	154.4	3360	231.7	8960	617.8
UFBX1	T-321	1	300 Series	2420	166.9	3630	250.3	9680	667.4
UFBX1	T-316L	1	300 Series	2420	166.9	3630	250.3	9680	667.4
UFC1	T-321	1	300 Series	2480	171.0	3720	256.5	9920	684.0
UFC1	T-316	1	300 Series	2480	171.0	3720	256.5	9920	684.0
462 / 862	T-321/T-316L	2	300 Series	2613	180.2	3920	270.3	10452	720.6
401M	T-321	1	T-321	2660	183.4	4000	275.8	10650	734.3
401H	T-316L	1	T-321	2660	183.4	4000	275.8	10650	734.3
UFBX2	T-321	2	300 Series	3190	219.9	4785	329.9	12760	879.8
UFBX2	T-316L	2	300 Series	3190	219.9	4785	329.9	12760	879.8
UFC2	T-321	2	300 Series	4424	305.0	6635	457.5	17696	1220.1
UFC2	T-316	2	300 Series	4424	305.0	6635	457.5	17696	1220.1
402M	T-321	2	T-321	4500	310.3	6750	465.4	18000	1241.1
402H	T-316L	2	T-321	4500	310.3	6750	465.4	18000	1241.1
402X	T-316L	2	T-321	5300	365.4	7950	548.1	21200	1461.7
RF67	T-321	3	T-321	12000*	827.4*	18000	1241.1	-	-
SPECIALTY ALLOYS									
A400	Monel®	-	-	180	12.4	270	18.6	-	-
A400-1	Monel®	1	Monel®	2250	155.1	3375	232.7	9000	620.5
A400-2	Monel®	2	Monel®	3025	208.6	4535	312.7	12100	834.3
A625	Inconel® 625	-	-	228	15.7	342	23.6	-	-
A625-1	Inconel® 625	1	T-321 or 625	2660	183.4	3990	275.1	10640	733.6
A276	Hastelloy® C276	-	-	80	5.5	120	8.3	-	-
A276-1	Hastelloy® C276	1	300 or C276	1550	106.9	2325	160.3	6200	427.5

*Available Only as a US Factory welded assembly. Contact US Hose Corp for specific advice on pressure capabilities, testing, compatibilities and motion requirements as this product is unique.

1/4" (6mm) Metal Hose Technical Data

T-321 & T-316L STAINLESS STEEL										
Hose Type	Hose OD		Weight Per		Min. Live Length for Vibration		Min. Bend Radius			
	in	mm	lb/ft	kg/m	in	mm	Static		Dynamic	
							in	mm	in	mm
460 / 860	0.42	10.7	0.06	0.09	3.50	89	0.63	16	3.50	89
UFBX0	0.40	10.2	0.05	0.07	3.00	76	0.63	16	4.30	109
UFBX0	0.40	10.2	0.05	0.07	3.00	76	0.63	16	4.30	109
AFBX0	0.38	9.7	0.05	0.07	3.50	89	0.59	15	3.15	80
AFCX0	0.38	9.7	0.08	0.12	3.50	89	0.59	15	3.15	80
UFCO	0.51	13.0	0.13	0.20	3.75	95	0.63	16	3.94	100
UFCO	0.51	13.0	0.13	0.20	3.75	95	0.63	16	3.94	100
400M	0.49	12.4	0.14	0.21	3.75	95	0.88	22	5.50	140
400H	0.49	12.4	0.14	0.21	3.75	95	0.88	22	5.50	140
AFBX1	0.43	10.9	0.06	0.09	3.50	89	0.98	25	3.15	80
AFCX1	0.43	10.9	0.09	0.13	3.50	89	0.98	25	3.15	80
461 / 861	0.48	12.2	0.13	0.19	3.50	89	0.63	16	3.50	89
UFBX1	0.45	11.4	0.11	0.16	3.00	76	1.00	25	4.30	109
UFBX1	0.45	11.4	0.11	0.16	3.00	76	1.00	25	4.30	109
UFC1	0.57	14.5	0.21	0.31	3.75	95	0.98	25	3.94	100
UFC1	0.57	14.5	0.21	0.31	3.75	95	0.98	25	3.94	100
462 / 862	0.56	14.2	0.20	0.30	3.50	89	0.63	16	3.50	89
401M	0.55	14.0	0.21	0.31	3.75	95	0.88	22	5.50	140
401H	0.55	14.0	0.21	0.31	3.75	95	0.88	22	5.50	140
UFBX2	0.50	12.7	0.16	0.24	3.00	76	1.00	25	4.30	109
UFBX2	0.50	12.7	0.16	0.24	3.00	76	1.00	25	4.30	109
UFC2	0.63	15.9	0.28	0.42	3.75	95	0.98	25	3.94	100
UFC2	0.63	15.9	0.28	0.42	3.75	95	0.98	25	3.94	100
402M	0.61	15.5	0.28	0.42	3.75	95	0.88	22	5.50	140
402H	0.61	15.5	0.28	0.42	3.75	95	0.88	22	5.50	140
402X	0.63	16.0	0.39	0.58	4.25	108	2.00	51	8.25	210
RF67	0.68	17.3	0.62	0.92	6.00	152	2.50	64	11.50	292
SPECIALTY ALLOYS										
A400	0.49	12.4	0.16	0.24	3.75	95	0.88	22	5.50	140
A400-1	0.55	14.0	0.23	0.34	3.75	95	0.88	22	5.50	140
A400-2	0.61	15.5	0.31	0.46	3.50	89	0.88	22	5.50	140
A625	0.49	12.4	0.11	0.16	3.50	89	0.88	22	5.00	127
A625-1	0.55	14.0	0.18	0.27	3.50	89	0.88	22	5.00	127
A276	0.84	21.3	0.31	0.46	4.50	114	1.50	38	6.00	152
A276-1	0.90	22.9	0.42	0.63	4.50	114	1.50	38	6.00	152

3/8" (10mm) Metal Hose Pressure Ratings

T-321 & T-316L STAINLESS STEEL									
Hose Type	Hose Alloy	Braid		Full Vacuum to Maximum Pressure (at 70° F/21°C)					
				Working		Test		Burst	
		Layers	Alloy	psi	bar	psi	bar	psi	bar
460 / 860	T-321/T-316L	-	-	50	3.4	75	5.2	-	-
UFBX0	T-321	-	-	80	5.5	120	8.3	-	-
UFBX0	T-316L	-	-	80	5.5	120	8.3	-	-
AFBX0	T-321/T-316	-	-	80	5.5	120	8.3	-	-
AFCX0	T-321/T-316L	-	-	80	5.5	120	8.3	-	-
UFCO	T-321	-	-	80	5.5	120	8.3	-	-
UFCO	T-316	-	-	80	5.5	120	8.3	-	-
400M	T-321	-	-	100	6.9	150	10.3	-	-
400H	T-316L	-	-	133	9.2	200	13.8	-	-
AFBX1	T-321/T-316	1	300 Series	1350	93.1	2025	139.6	5400	372.3
AFCX1	T-321/T-316L	1	300 Series	1350	93.1	2025	139.6	5400	372.3
461 / 861	T-321/T-316L	1	300 Series	1450	100.0	2175	150.0	5800	399.9
UFBX1	T-321	1	300 Series	1450	100.0	2175	150.0	5800	399.9
UFBX1	T-316L	1	300 Series	1450	100.0	2175	150.0	5800	399.9
401M	T-321	1	T-321	1610	111.0	2415	166.5	6440	444.0
401H	T-316L	1	T-321	1610	111.0	2415	166.5	6440	444.0
UFC1	T-321	1	300 Series	2190	151.0	3285	226.5	8760	604.0
UFC1	T-316	1	300 Series	2190	151.0	3285	226.5	8760	604.0
462 / 862	T-321/T-316L	2	300 Series	2430	167.5	3645	251.3	9720	670.2
402M	T-321	2	T-321	2435	167.9	3650	251.7	9750	672.2
UFBX2	T-321	2	300 Series	2580	177.9	3870	266.8	10320	711.5
UFBX2	T-316L	2	300 Series	2580	177.9	3870	266.8	10320	711.5
402H	T-316L	2	T-321	2900	199.9	4325	298.2	11600	799.8
UFC2	T-321	2	300 Series	3771	260.0	5656	390.0	15084	1040.0
UFC2	T-316	2	300 Series	3771	260.0	5656	390.0	15084	1040.0
402X	T-316L	2	T-321	3900	268.9	5850	403.3	15600	1075.6
RF67	T-321	3	T-321	9000*	620.5*	13500	930.8	-	-
SPECIALTY ALLOYS									
A400	Monel®	-	-	140	9.7	210	14.5	-	-
A400-1	Monel®	1	Monel®	1575	108.6	2360	162.7	6300	434.4
A400-2	Monel®	2	Monel®	2050	141.3	3075	212.0	8200	565.4
A625	Inconel® 625	-	-	150	10.3	225	15.5	-	-
A625-1	Inconel® 625	1	T-321 or 625	1610	111.0	2415	166.5	6440	444.0

*Available Only as a US Factory welded assembly. Contact US Hose Corp for specific advice on pressure capabilities, testing, compatibilities and motion requirements as this product is unique.

3/8" (10mm) Metal Hose Technical Data

T-321 & T-316L STAINLESS STEEL										
Hose Type	Hose OD		Weight Per		Min. Live Length for Vibration		Min. Bend Radius			
	in	mm	lb/ft	kg/m	in	mm	Static		Dynamic	
							in	mm	in	mm
460 / 860	0.57	14.5	0.09	0.13	4.00	102	0.88	22	4.00	102
UFBX0	0.59	15.0	0.11	0.16	3.50	89	0.87	22	6.00	152
UFBX0	0.59	15.0	0.11	0.16	3.50	89	0.87	22	6.00	152
AFBX0	0.56	14.2	0.07	0.10	4.50	114	0.71	18	5.04	128
AFCX0	0.56	14.2	0.11	0.16	4.50	114	0.71	18	5.04	128
UFCO	0.70	17.8	0.19	0.29	4.25	108	0.87	22	5.91	150
UFCO	0.70	17.8	0.19	0.29	4.50	114	0.87	22	5.91	150
400M	0.66	16.8	0.18	0.27	4.25	108	1.13	29	5.50	140
400H	0.66	16.8	0.21	0.31	4.50	114	1.13	29	6.00	152
AFBX1	0.61	15.5	0.16	0.24	4.50	114	1.50	38	5.04	128
AFCX1	0.61	15.5	0.20	0.30	4.50	114	1.50	38	5.04	128
461 / 861	0.63	16.0	0.17	0.25	4.00	102	0.88	22	4.00	102
UFBX1	0.64	16.3	0.18	0.27	3.50	89	1.50	38	6.00	152
UFBX1	0.64	16.3	0.18	0.27	3.50	89	1.50	38	6.00	152
401M	0.73	18.5	0.25	0.37	4.25	108	1.13	29	5.50	140
401H	0.73	18.5	0.29	0.43	4.50	114	1.13	29	6.00	152
UFC1	0.76	19.3	0.32	0.48	4.25	108	1.57	40	5.91	150
UFC1	0.76	19.3	0.32	0.48	4.50	114	1.57	40	5.91	150
462 / 862	0.69	17.5	0.25	0.37	4.00	102	0.88	22	4.00	102
402M	0.79	20.1	0.35	0.52	4.25	108	1.13	29	5.50	140
UFBX2	0.69	17.5	0.25	0.37	3.50	89	1.50	38	6.00	152
UFBX2	0.69	17.5	0.25	0.37	3.50	89	1.50	38	6.00	152
402H	0.79	20.1	0.38	0.57	4.50	114	1.13	29	6.00	152
UFC2	0.81	20.7	0.45	0.67	4.25	108	1.57	40	5.91	150
UFC2	0.81	20.7	0.45	0.67	4.50	114	1.57	40	5.91	150
402X	0.81	20.6	0.53	0.79	5.00	127	2.50	64	9.00	229
RF67	0.90	22.9	0.97	1.44	7.00	178	3.75	95	15.00	381
SPECIALTY ALLOYS										
A400	0.66	16.8	0.24	0.36	4.50	114	1.13	29	6.00	152
A400-1	0.73	18.5	0.34	0.51	4.50	114	1.13	29	6.00	152
A400-2	0.79	20.1	0.44	0.65	4.50	114	1.13	29	6.00	152
A625	0.66	16.8	0.15	0.22	4.25	108	1.13	29	5.50	140
A625-1	0.73	18.5	0.23	0.34	4.25	108	1.13	29	5.50	140

1/2" (12mm) Metal Hose Pressure Ratings

T-321 & T-316L STAINLESS STEEL									
Hose Type	Hose Alloy	Braid		Full Vacuum to Maximum Pressure (at 70° F/21°C)					
				Working		Test		Burst	
		Layers	Alloy	psi	bar	psi	bar	psi	bar
460 / 860	T-321/T-316L	-	-	50	3.4	75	5.2	-	-
UFBX0	T-321	-	-	80	5.5	120	8.3	-	-
UFBX0	T-316L	-	-	80	5.5	120	8.3	-	-
400M	T-321	-	-	80	5.5	120	8.3	-	-
AFBX0	T-321/T-316	-	-	80	5.5	120	8.3	-	-
AFCX0	T-321/T-316L	-	-	80	5.5	120	8.3	-	-
UFCO	T-321	-	-	80	5.5	120	8.3	-	-
UFCO	T-316	-	-	80	5.5	120	8.3	-	-
400H	T-316L	-	-	133	9.2	200	13.8	-	-
461 / 861	T-321/T-316L	1	300 Series	1040	71.7	1560	107.6	4160	286.8
UFBX1	T-321	1	300 Series	1075	74.1	1615	111.4	4300	296.5
AFBX1	T-321/T-316	1	300 Series	1200	82.7	1800	124.1	4800	330.9
AFCX1	T-321/T-316L	1	300 Series	1200	82.7	1800	124.1	4800	330.9
401M	T-321	1	T-321	1310	90.3	1965	135.5	5240	361.3
401H	T-316L	1	T-321	1310	90.3	1965	135.5	5240	361.3
UFBX1	T-316L	1	300 Series	1375	94.8	2063	142.2	5500	379.2
UFBX2	T-321	2	300 Series	1500	103.4	2250	155.1	6000	413.7
UFC1	T-321	1	300 Series	1653	114.0	2480	171.0	6612	455.9
UFC1	T-316	1	300 Series	1653	114.0	2480	171.0	6612	455.9
462 / 862	T-321/T-316L	2	300 Series	1665	114.8	2498	172.2	6660	459.2
UFBX2	T-316L	2	300 Series	2230	153.8	3345	230.6	8920	615.0
402M	T-321	2	T-321	2355	162.4	3530	243.4	9420	649.5
402H	T-316L	2	T-321	2355	162.4	3530	243.4	9420	649.5
UFC2	T-321	2	300 Series	2973	205.0	4460	307.5	11892	819.9
UFC2	T-316	2	300 Series	2973	205.0	4460	307.5	11892	819.9
402X	T-316L	2	T-321	3600	248.2	5400	372.3	14400	992.8
RF67	T-321	2	T-321	8500*	586.1*	12750	879.1	-	-
SPECIALTY ALLOYS									
A400	Monel®	-	-	120	8.3	180	12.4	-	-
A400-1	Monel®	1	Monel®	835	57.6	1250	86.2	3340	230.3
A400-2	Monel®	2	Monel®	1500	103.4	2250	155.1	6000	413.7
A625	Inconel® 625	-	-	79	5.4	119	8.2	-	-
A625-1	Inconel® 625	1	T-321 or 625	1310	90.3	1965	135.5	5240	361.3
A276	Hastelloy® C276	-	-	80	5.5	120	8.3	-	-
A276-1	Hastelloy® C276	1	300 or C276	1551	106.9	2325	160.3	6200	427.5

*Available Only as a US Factory welded assembly. Contact US Hose Corp for specific advice on pressure capabilities, testing, compatibilities and motion requirements as this product is unique.

1/2" (12mm) Metal Hose Technical Data

T-321 & T-316L STAINLESS STEEL										
Hose Type	Hose OD		Weight Per		Min. Live Length for Vibration		Min. Bend Radius			
							Static		Dynamic	
	in	mm	lb/ft	kg/m	in	mm	in	mm	in	mm
460 / 860	0.75	19.1	0.12	0.18	4.50	114	1.13	29	5.50	140
UFBX0	0.77	19.6	0.11	0.16	4.25	108	0.94	24	6.50	165
UFBX0	0.75	19.1	0.13	0.19	4.25	108	0.94	24	6.50	165
400M	0.84	21.3	0.27	0.40	4.50	114	1.50	38	6.00	152
AFBX0	0.79	20.1	0.12	0.18	4.75	121	1.10	28	6.30	160
AFCX0	0.79	20.1	0.18	0.27	4.75	121	0.91	23	5.73	145
UFCO	0.86	21.8	0.24	0.35	4.50	114	0.94	24	5.91	150
UFCO	0.86	21.8	0.24	0.35	4.50	114	0.94	24	5.91	150
400H	0.84	21.3	0.36	0.54	5.00	127	1.50	38	7.00	178
461 / 861	0.81	20.6	0.21	0.31	4.50	114	1.13	29	5.50	140
UFBX1	0.83	21.1	0.22	0.33	4.25	108	1.75	44	6.50	165
AFBX1	0.84	21.3	0.26	0.39	4.75	121	2.28	58	6.30	160
AFCX1	0.84	21.3	0.27	0.40	4.75	121	2.02	51	5.73	145
401M	0.90	22.9	0.38	0.57	4.50	114	1.50	38	6.00	152
401H	0.90	22.9	0.47	0.70	5.00	127	1.50	38	7.00	178
UFBX1	0.81	20.6	0.24	0.36	4.25	108	1.75	44	6.50	165
UFBX2	0.88	22.4	0.33	0.49	4.25	108	1.75	44	6.50	165
UFC1	0.92	23.3	0.39	0.58	4.50	114	1.97	50	5.91	150
UFC1	0.92	23.3	0.39	0.58	4.50	114	1.97	50	5.91	150
462 / 862	0.87	22.1	0.30	0.45	4.50	114	1.13	29	5.50	140
UFBX2	0.87	22.1	0.35	0.52	4.25	108	1.75	44	6.50	165
402M	0.96	24.4	0.49	0.73	4.50	114	1.50	38	6.00	152
402H	0.96	24.4	0.58	0.86	5.00	127	1.50	38	7.00	178
UFC2	0.97	24.7	0.54	0.81	4.50	114	1.97	50	5.91	150
UFC2	0.97	24.7	0.54	0.81	4.50	114	1.97	50	5.91	150
402X	1.05	26.7	0.75	1.12	6.00	152	3.00	76	10.50	267
RF67	1.04	26.4	1.34	1.99	8.00	203	4.50	114	16.50	419
SPECIALTY ALLOYS										
A400	0.84	21.3	0.40	0.60	5.00	127	1.50	38	7.00	178
A400-1	0.90	22.9	0.51	0.76	5.00	127	1.50	38	7.00	178
A400-2	0.96	24.4	0.64	0.95	5.00	127	1.50	38	7.00	178
A625	0.84	21.3	0.21	0.31	4.50	114	1.50	38	6.00	152
A625-1	0.90	22.9	0.32	0.48	4.50	114	1.50	38	6.00	152
A276	0.84	21.3	0.31	0.46	4.50	114	1.50	38	6.00	152
A276-1	0.90	22.9	0.42	0.63	4.50	114	1.50	38	6.00	152

3/4" (20mm) Metal Hose Pressure Ratings

T-321 & T-316L STAINLESS STEEL									
Hose Type	Hose Alloy	Braid		Full Vacuum to Maximum Pressure (at 70° F/21°C)					
				Working		Test		Burst	
		Layers	Alloy	psi	bar	psi	bar	psi	bar
460 / 860	T-321/T-316L	-	-	30	2.1	45	3.1	-	-
UFCO	T-321	-	-	59	4.1	89	6.1	-	-
UFCO	T-316	-	-	59	4.1	89	6.1	-	-
UFBX0	T-321	-	-	60	4.1	90	6.2	-	-
UFBX0	T-316L	-	-	60	4.1	90	6.2	-	-
AFBX0	T-321/T-316	-	-	60	4.1	90	6.2	-	-
AFCX0	T-321/T-316L	-	-	60	4.1	90	6.2	-	-
400M	T-321	-	-	70	4.8	105	7.2	-	-
400H	T-316L	-	-	100	6.9	150	10.3	-	-
461 / 861	T-321/T-316L	1	300 Series	600	41.4	900	62.1	2400	165.5
AFBX1	T-321/T-316	1	300 Series	875	60.3	1313	90.5	3500	241.3
AFCX1	T-321/T-316L	1	300 Series	875	60.3	1313	90.5	3500	241.3
401M	T-321	1	T-321	915	63.1	1370	94.5	3660	252.3
401H	T-316L	1	T-321	915	63.1	1370	94.5	3660	252.3
UFBX1	T-321	1	300 Series	950	65.5	1425	98.3	3800	262.0
UFBX1	T-316L	1	300 Series	1040	71.7	1560	107.6	4160	286.8
462 / 862	T-321/T-316L	2	300 Series	1080	74.5	1620	111.7	4320	297.9
UFBX2	T-321	2	300 Series	1250	86.2	1875	129.3	5000	344.7
UFC1	T-321	1	300 Series	1317	90.8	1975	136.2	5268	363.2
UFC1	T-316	1	300 Series	1317	90.8	1975	136.2	5268	363.2
402M	T-321	2	T-321	1650	113.8	2475	170.6	6600	455.1
402H	T-316L	2	T-321	1650	113.8	2475	170.6	6600	455.1
UFBX2	T-316L	2	300 Series	1900	131.0	2850	196.5	7600	524.0
UFC2	T-321	2	300 Series	2176	150.0	3263	225.0	8704	600.1
UFC2	T-316	2	300 Series	2176	150.0	3263	225.0	8704	600.1
402X	T-316L	2	T-321	3550	244.8	5325	367.1	14200	979.1
RF67	T-321	3	T-321	6800*	468.8*	10200	703.3	-	-
SPECIALTY ALLOYS									
A400	Monel®	-	-	90	6.2	135	9.3	-	-
A400-1	Monel®	1	Monel®	600	41.4	900	62.1	2400	165.5
A400-2	Monel®	2	Monel®	1080	74.5	1620	111.7	4320	297.9
A625	Inconel® 625	-	-	32	2.2	48	3.3	-	-
A625-1	Inconel® 625	1	T-321 or 625	915	63.1	1373	94.7	3660	252.3
A276	Hastelloy® C276	-	-	70	4.8	105	7.2	-	-
A276-1	Hastelloy® C276	1	300 or C276	915	63.1	1370	94.5	3660	252.3

*Available Only as a US Factory welded assembly. Contact US Hose Corp for specific advice on pressure capabilities, testing, compatibilities and motion requirements as this product is unique.

3/4" (20mm) Metal Hose Technical Data

T-321 & T-316L STAINLESS STEEL										
Hose Type	Hose OD		Weight Per		Min. Live Length for Vibration		Min. Bend Radius			
							Static		Dynamic	
	in	mm	lb/ft	kg/m	in	mm	in	mm	in	mm
460 / 860	1.04	26.4	0.18	0.27	5.50	140	1.50	38	6.00	152
UFCO	1.10	28.0	0.32	0.48	5.50	140	1.18	30	7.87	200
UFCO	1.10	28.0	0.32	0.48	5.50	140	1.18	30	7.87	200
UFBX0	1.02	25.9	0.18	0.27	4.50	114	1.20	30	8.00	203
UFBX0	1.00	25.4	0.24	0.36	4.50	114	1.20	30	7.90	201
AFBX0	1.06	26.9	0.17	0.25	5.25	133	1.26	32	6.61	168
AFCX0	1.06	26.9	0.26	0.39	5.25	133	1.26	32	6.61	168
400M	1.21	30.7	0.51	0.76	5.50	140	2.13	54	8.00	203
400H	1.21	30.7	0.71	1.06	5.75	146	2.13	54	8.50	216
461 / 861	1.10	27.9	0.30	0.45	5.50	140	1.50	38	6.00	152
AFBX1	1.11	28.2	0.33	0.49	5.25	133	2.76	70	6.61	168
AFCX1	1.11	28.2	0.27	0.40	5.25	133	2.76	70	6.61	168
401M	1.27	32.3	0.67	1.00	5.50	140	2.13	54	8.00	203
401H	1.27	32.3	0.87	1.29	5.75	146	2.13	54	8.50	216
UFBX1	1.08	27.4	0.35	0.52	4.50	114	2.75	70	8.00	203
UFBX1	1.07	27.2	0.91	1.35	4.50	114	2.75	70	8.00	203
462 / 862	1.16	29.5	0.33	0.49	5.50	140	1.50	38	6.00	152
UFBX2	1.14	29.0	0.52	0.77	4.50	114	2.75	70	8.00	203
UFC1	1.19	30.2	0.58	0.86	5.50	140	2.76	70	7.87	200
UFC1	1.19	30.2	0.58	0.86	5.50	140	2.76	70	7.87	200
402M	1.33	33.8	0.84	1.25	5.50	140	2.13	54	8.00	203
402H	1.33	33.8	1.04	1.55	5.75	146	2.13	54	8.50	216
UFBX2	1.14	29.0	0.58	0.86	4.50	114	2.75	70	8.00	203
UFC2	1.27	32.3	0.83	1.24	5.50	140	2.76	70	7.87	200
UFC2	1.27	32.3	0.81	1.20	5.50	140	2.76	70	7.87	200
402X	1.43	36.3	1.63	2.43	7.00	178	4.00	102	12.75	324
RF67	1.52	38.6	2.56	3.81	9.00	229	6.50	165	30.50	775
SPECIALTY ALLOYS										
A400	1.21	30.7	0.79	1.18	5.75	146	2.13	54	8.50	216
A400-1	1.27	32.3	0.96	1.43	5.75	146	2.13	54	8.50	216
A400-2	1.33	33.8	1.15	1.71	5.75	146	2.13	54	8.50	216
A625	1.21	30.7	0.34	0.51	5.50	140	2.13	54	8.00	203
A625-1	1.27	32.3	0.50	0.74	5.50	140	2.13	54	8.00	203
A276	1.21	30.7	0.49	0.73	5.50	140	2.13	54	8.00	203
A276-1	1.27	32.3	0.67	1.00	5.50	140	2.13	54	8.00	203

1" (25mm) Metal Hose Pressure Ratings

T-321 & T-316L STAINLESS STEEL									
Hose Type	Hose Alloy	Braid		Full Vacuum to Maximum Pressure (at 70° F/21°C)					
				Working		Test		Burst	
		Layers	Alloy	psi	bar	psi	bar	psi	bar
460 / 860	T-321/T-316L	-	-	25	1.7	37	2.6	-	-
400M	T-321	-	-	43	3.0	65	4.5	-	-
UFCO	T-321	-	-	59	4.1	89	6.1	-	-
UFCO	T-316	-	-	59	4.1	89	6.1	-	-
UFBX0	T-321	-	-	60	4.1	90	6.2	-	-
UFBX0	T-316L	-	-	60	4.1	90	6.2	-	-
AFBX0	T-321/T-316	-	-	60	4.1	90	6.2	-	-
AFCX0	T-321/T-316L	-	-	60	4.1	90	6.2	-	-
400H	T-316L	-	-	63	4.3	95	6.6	-	-
461 / 861	T-321/T-316L	1	300 Series	580	40.0	870	60.0	2320	160.0
401M	T-321	1	T-321	645	44.5	965	66.5	2580	177.9
401H	T-316L	1	T-321	645	44.5	965	66.5	2580	177.9
UFBX1	T-321	1	300 Series	725	50.0	1087	74.9	2900	199.9
AFBX1	T-321/T-316	1	300 Series	900	62.1	1350	93.1	3600	248.2
AFCX1	T-321/T-316L	1	300 Series	900	62.1	1350	93.1	3600	248.2
UFBX1	T-316L	1	300 Series	940	64.8	1410	97.2	3760	259.2
462 / 862	T-321/T-316L	2	300 Series	1035	71.4	1550	106.9	4140	285.4
UFBX2	T-321	2	300 Series	1110	76.5	1650	113.8	4470	308.2
UFC1	T-321	1	300 Series	1152	79.4	1727	119.1	4608	317.7
UFC1	T-316	1	300 Series	1152	79.4	1727	119.1	4608	317.7
402M	T-321	2	T-321	1165	80.3	1745	120.3	4660	321.3
402H	T-316L	2	T-321	1165	80.3	1745	120.3	4660	321.3
UFBX2	T-316L	2	300 Series	1480	102.0	2220	153.1	5920	408.2
UFC2	T-321	2	300 Series	1740	120.0	2611	180.0	6960	479.9
UFC2	T-316	2	300 Series	1740	120.0	2611	180.0	6960	479.9
402X	T-316L	2	T-321	2800	193.1	4200	289.6	11200	772.2
RF67	T-321	3	T-321	6250*	430.9*	9375	646.4	-	-
SPECIALTY ALLOYS									
A400	Monel®	-	-	56	3.9	85	5.9	-	-
A400-1	Monel®	1	Monel®	420	28.9	630	43.4	1680	115.8
A400-2	Monel®	2	Monel®	755	52.0	1130	77.9	3025	208.6
A625	Inconel® 625	-	-	38	2.6	57	3.9	-	-
A625-1	Inconel® 625	1	T-321 or 625	645	44.5	968	66.7	2580	177.9
A276	Hastelloy® C276	-	-	43	3.0	65	4.5	-	-
A276-1	Hastelloy® C276	1	300 or C276	645	44.5	965	66.5	2580	177.9

*Available Only as a US Factory welded assembly. Contact US Hose Corp for specific advice on pressure capabilities, testing, compatibilities and motion requirements as this product is unique.

1" (25mm) Metal Hose Technical Data

T-321 & T-316L STAINLESS STEEL										
Hose Type	Hose OD		Weight Per		Min. Live Length for Vibration		Min. Bend Radius			
							Static		Dynamic	
	in	mm	lb/ft	kg/m	in	mm	in	mm	in	mm
460 / 860	1.36	34.5	0.28	0.42	6.25	159	2.00	51	7.00	178
400M	1.53	38.9	0.75	1.12	6.50	165	2.75	70	9.00	229
UFCO	1.38	35.0	0.43	0.64	6.50	165	1.73	44	7.87	200
UFCO	1.38	35.0	0.43	0.64	6.50	165	1.73	44	7.87	200
UFBX0	1.33	33.8	0.21	0.31	5.50	140	1.70	43	8.00	203
UFBX0	1.29	32.8	0.35	0.52	5.50	140	1.70	43	8.00	203
AFBX0	1.27	32.3	0.23	0.34	5.50	140	1.58	40	7.48	190
AFCX0	1.27	32.3	0.35	0.52	5.50	140	1.58	40	7.48	190
400H	1.53	38.9	0.92	1.37	7.00	178	2.75	70	10.00	254
461 / 861	1.42	36.1	0.45	0.67	6.25	159	2.00	51	7.00	178
401M	1.59	40.4	0.93	1.38	6.50	165	2.75	70	9.00	229
401H	1.59	40.4	1.11	1.65	7.00	178	2.75	70	10.00	254
UFBX1	1.41	35.8	0.47	0.70	5.50	140	3.50	89	8.00	203
AFBX1	1.34	34.0	0.52	0.77	5.50	140	3.35	85	7.48	190
AFCX1	1.34	34.0	0.63	0.94	6.50	165	3.35	85	7.48	190
UFBX1	1.39	35.3	0.61	0.91	5.50	140	3.50	89	8.00	203
462 / 862	1.48	37.6	0.62	0.92	6.25	159	2.00	51	7.00	178
UFBX2	1.49	37.8	0.73	1.09	5.50	140	3.50	89	8.00	203
UFC1	1.46	37.2	0.76	1.13	6.50	165	3.54	90	7.87	200
UFC1	1.46	37.2	0.74	1.10	6.50	165	3.54	90	7.87	200
402M	1.65	41.9	1.13	1.68	6.50	165	2.75	70	9.00	229
402H	1.65	41.9	1.30	1.93	7.00	178	2.75	70	10.00	254
UFBX2	1.49	37.8	0.87	1.29	5.50	140	3.50	89	8.00	203
UFC2	1.55	39.3	1.09	1.62	6.50	165	3.54	90	7.87	200
UFC2	1.55	39.3	1.08	1.60	6.50	165	3.54	90	7.87	200
402X	1.75	44.5	2.07	3.08	8.25	210	5.25	133	15.00	381
RF67	1.93	49.0	3.69	5.49	10.00	254	9.00	229	35.00	889
SPECIALTY ALLOYS										
A400	1.53	38.9	1.02	1.52	7.00	178	2.75	70	10.00	254
A400-1	1.59	38.9	1.22	1.82	7.00	178	2.75	70	10.00	254
A400-2	1.65	41.9	1.44	2.14	7.00	178	2.75	70	10.00	254
A625	1.53	38.9	0.59	0.88	6.50	165	2.75	70	9.00	229
A625-1	1.59	40.4	0.78	1.16	6.50	165	2.75	70	9.00	229
A276	1.53	38.9	0.80	1.19	6.50	165	2.75	70	9.00	229
A276-1	1.59	40.4	0.98	1.46	6.50	165	2.75	70	9.00	229

1/4" (32mm) Metal Hose Pressure Ratings

T-321 & T-316L STAINLESS STEEL									
Hose Type	Hose Alloy	Braid		Full Vacuum to Maximum Pressure (at 70° F/21°C)					
				Working		Test		Burst	
		Layers	Alloy	psi	bar	psi	bar	psi	bar
460 / 860	T-321/T-316L	-	-	20	1.4	30	2.1	-	-
400M	T-321	-	-	29	2.0	43	3.0	-	-
UFCO	T-321	-	-	46	3.2	70	4.8	-	-
UFCO	T-316	-	-	46	3.2	70	4.8	-	-
UFBX0	T-321	-	-	50	3.4	75	5.2	-	-
UFBX0	T-316L	-	-	50	3.4	75	5.2	-	-
AFBX0	T-321/T-316	-	-	50	3.4	75	5.2	-	-
AFCX0	T-321/T-316L	-	-	50	3.4	75	5.2	-	-
400H	T-316L	-	-	60	4.1	90	6.2	-	-
461 / 861	T-321/T-316L	1	300 Series	450	31.0	675	46.5	1800	124.1
AFBX1	T-321/T-316	1	300 Series	515	35.5	773	53.3	2060	142.0
AFCX1	T-321/T-316L	1	300 Series	515	35.5	773	53.3	2060	142.0
401M	T-321	1	T-321	545	37.6	820	56.5	2180	150.3
401H	T-316L	1	T-321	545	37.6	820	56.5	2180	150.3
UFBX1	T-321	1	300 Series	563	38.8	845	58.3	2252	155.3
UFBX1	T-316L	1	300 Series	667	46.0	1000	68.9	2668	184.0
AFBX2	T-321/T-316	2	300 Series	800	55.2	1200	82.7	3200	220.6
AFCX2	T-321/T-316L	2	300 Series	800	55.2	1200	82.7	3200	220.6
462 / 862	T-321/T-316L	2	300 Series	820	56.5	1230	84.8	3275	225.8
UFBX2	T-321	2	300 Series	825	56.9	1237	85.3	3300	227.5
UFC1	T-321	1	300 Series	856	59.0	1284	88.5	3424	236.1
UFC1	T-316	1	300 Series	856	59.0	1284	88.5	3424	236.1
402M	T-321	2	T-321	980	67.6	1470	101.4	3920	270.3
402H	T-316L	2	T-321	980	67.6	1470	101.4	3920	270.3
UFBX2	T-316L	2	300 Series	1230	84.8	1845	127.2	4920	339.2
UFC2	T-321	2	300 Series	1291	89.0	1936	133.5	5164	356.0
UFC2	T-316	2	300 Series	1291	89.0	1936	133.5	5164	356.0
402X	T-316L	2	T-321	2480	171.0	3720	256.5	9920	684.0
RF67	T-321	3	T-321	5500*	379.2*	8250	568.8	-	-
SPECIALTY ALLOYS									
A400	Monel®	-	-	53	3.7	80	5.5	-	-
A400-1	Monel®	1	Monel®	315	21.7	420	29.0	1270	87.6
A400-2	Monel®	2	Monel®	570	39.3	855	59.0	2285	157.5
A625	Inconel® 625	-	-	22	1.5	33	2.3	-	-
A625-1	Inconel® 625	1	T-321 or 625	545	37.6	818	56.4	2180	150.3
A276	Hastelloy® C276	-	-	29	2.0	42	2.9	-	-
A276-1	Hastelloy® C276	1	300 or C276	575	39.6	860	59.3	2300	158.6

*Available Only as a US Factory welded assembly. Contact US Hose Corp for specific advice on pressure capabilities, testing, compatibilities and motion requirements as this product is unique.

1/4" (32mm) Metal Hose Technical Data

T-321 & T-316L STAINLESS STEEL										
Hose Type	Hose OD		Weight Per		Min. Live Length for Vibration		Min. Bend Radius			
							Static		Dynamic	
	in	mm	lb/ft	kg/m	in	mm	in	mm	in	mm
460 / 860	1.68	42.7	0.46	0.68	7.00	178	2.50	64	11.50	292
400M	1.86	47.2	0.96	1.43	7.00	178	3.25	83	10.50	267
UFCO	1.83	46.5	0.74	1.10	7.00	178	2.17	55	9.84	250
UFCO	1.83	46.5	0.60	0.90	7.00	178	2.17	55	9.84	250
UFBX0	1.62	41.1	0.27	0.40	6.00	152	2.20	56	10.00	254
UFBX0	1.60	40.6	0.43	0.64	6.00	152	2.20	56	10.00	254
AFBX0	1.62	41.1	0.29	0.43	7.50	191	1.97	50	10.04	255
AFCX0	1.62	41.1	0.44	0.65	7.50	191	1.97	50	10.04	255
400H	1.86	47.2	1.45	2.16	7.50	191	3.25	83	11.50	292
461 / 861	1.74	44.2	0.66	0.98	7.00	178	2.50	64	11.50	292
AFBX1	1.67	42.4	0.53	0.79	7.50	191	4.13	105	10.04	255
AFCX1	1.67	42.4	0.68	1.01	7.50	191	4.13	105	10.04	255
401M	1.92	48.8	1.20	1.79	7.00	178	3.25	83	10.50	267
401H	1.92	48.8	1.69	2.51	7.50	191	3.25	83	11.50	292
UFBX1	1.70	43.2	0.57	0.85	6.00	152	4.50	114	10.00	254
UFBX1	1.69	42.9	0.73	1.09	6.00	152	4.50	114	10.00	254
AFBX2	1.72	43.7	0.77	1.15	7.50	191	4.13	105	10.04	255
AFCX2	1.72	43.7	0.92	1.37	7.50	191	4.13	105	10.04	255
462 / 862	1.80	45.7	0.86	1.28	7.00	178	2.50	64	11.50	292
UFBX2	1.78	45.2	0.87	1.29	6.00	152	4.50	114	10.00	254
UFC1	1.91	48.6	1.18	1.76	7.00	178	4.25	108	9.84	250
UFC1	1.91	48.6	1.08	1.60	7.00	178	4.25	108	9.84	250
402M	1.98	50.3	1.45	2.16	7.00	178	3.25	83	10.50	267
402H	1.98	50.3	1.94	2.89	7.50	191	3.25	83	11.50	292
UFBX2	1.78	45.2	1.03	1.53	6.00	152	4.50	114	10.00	254
UFC2	2.00	50.7	1.63	2.42	7.00	178	4.25	108	9.84	250
UFC2	2.00	50.7	1.48	2.20	7.00	178	4.25	108	9.84	250
402X	2.08	52.8	2.93	4.36	9.00	229	6.50	165	17.25	438
RF67	2.15	54.6	5.08	7.56	12.00	305	10.00	254	38.00	965
SPECIALTY ALLOYS										
A400	1.86	47.2	1.61	2.40	7.50	191	3.25	83	11.50	292
A400-1	1.92	48.8	1.84	2.74	7.50	191	3.25	83	11.50	292
A400-2	1.98	50.3	2.08	3.10	7.50	191	3.25	83	11.50	292
A625	1.86	47.2	0.78	1.16	7.00	178	3.25	83	10.50	267
A625-1	1.92	48.8	1.02	1.52	7.00	178	3.25	83	10.50	267
A276	1.86	47.2	1.05	1.56	7.00	178	3.25	83	10.50	267
A276-1	1.92	48.8	1.29	1.92	7.00	178	3.25	83	10.50	267

1 1/2" (40mm) Metal Hose Pressure Ratings

T-321 & T-316L STAINLESS STEEL									
Hose Type	Hose Alloy	Braid		Full Vacuum to Maximum Pressure (at 70° F/21°C)					
				Working		Test		Burst	
		Layers	Alloy	psi	bar	psi	bar	psi	bar
460 / 860	T-321/T-316L	-	-	15	1.0	23	1.6	-	-
400M	T-321	-	-	31	2.1	47	3.2	-	-
UFBX0	T-321	-	-	35	2.4	53	3.7	-	-
UFBX0	T-316L	-	-	35	2.4	53	3.7	-	-
UFC0	T-321	-	-	35	2.4	52	3.6	-	-
UFC0	T-316	-	-	35	2.4	52	3.6	-	-
AFBX0	T-321/T-316	-	-	36	2.5	54	3.7	-	-
AFCX0	T-321/T-316L	-	-	36	2.5	54	3.7	-	-
400H	T-316L	-	-	43	3.0	65	4.5	-	-
461 / 861	T-321/T-316L	1	300 Series	410	28.3	615	42.4	1640	113.1
AFBX1	T-321/T-316	1	300 Series	435	30.0	653	45.0	1740	120.0
AFCX1	T-321/T-316L	1	300 Series	435	30.0	653	45.0	1740	120.0
UFBX1	T-321	1	300 Series	500	34.5	750	51.7	2000	137.9
401M	T-321	1	T-321	560	38.6	840	57.9	2240	154.4
401H	T-316L	1	T-321	560	38.6	840	57.9	2240	154.4
UFBX1	T-316L	1	300 Series	580	40.0	870	60.0	2320	160.0
462 / 862	T-321/T-316L	2	300 Series	650	44.8	975	67.2	260	17.9
UFC1	T-321	1	300 Series	667	46.0	1001	69.0	2668	184.0
UFC1	T-316	1	300 Series	667	46.0	1001	69.0	2668	184.0
UFBX2	T-321	2	300 Series	800	55.2	1200	82.7	3200	220.6
AFBX2	T-321/T-316	2	300 Series	800	55.2	1200	82.7	3200	220.6
AFCX2	T-321/T-316L	2	300 Series	800	55.2	1200	82.7	3200	220.6
402M	T-321	2	T-321	1000	68.9	1500	103.4	4000	275.8
402H	T-316L	2	T-321	1000	68.9	1500	103.4	4000	275.8
UFC2	T-321	2	300 Series	1030	71.0	1545	106.5	4120	284.1
UFC2	T-316	2	300 Series	1030	71.0	1545	106.5	4120	284.1
UFBX2	T-316L	2	300 Series	1045	72.1	1568	108.1	4180	288.2
402X	T-316L	2	T-321	2200	151.7	3300	227.5	8800	606.7
RF67	T-321	4	T-321	5200*	358.5*	7800	537.8	-	-
SPECIALTY ALLOYS									
A400	Monel®	-	-	37	2.6	55	3.8	-	-
A400-1	Monel®	1	Monel®	565	39.0	850	58.6	2260	155.8
A400-2	Monel®	2	Monel®	1015	70.0	1526	105.2	4060	279.9
A625	Inconel® 625	-	-	26	1.8	39	2.7	-	-
A625-1	Inconel® 625	1	T-321 or 625	560	38.6	840	57.9	2240	154.4
A276	Hastelloy® C276	-	-	31	2.1	47	3.2	-	-
A276-1	Hastelloy® C276	1	300 or C276	585	40.3	875	60.3	2340	161.3

*Available Only as a US Factory welded assembly. Contact US Hose Corp for specific advice on pressure capabilities, testing, compatibilities and motion requirements as this product is unique.

1 1/2" (40mm) Metal Hose Technical Data

T-321 & T-316L STAINLESS STEEL										
Hose Type	Hose OD		Weight Per		Min. Live Length for Vibration		Min. Bend Radius			
							Static		Dynamic	
	in	mm	lb/ft	kg/m	in	mm	in	mm	in	mm
460 / 860	2.02	51.3	0.59	0.88	7.75	197	3.00	76	14.00	356
400M	2.19	55.6	1.47	2.19	7.50	191	3.75	95	12.00	305
UFBX0	1.88	47.8	0.45	0.67	6.25	159	2.70	69	10.00	254
UFBX0	1.87	47.5	0.60	0.89	6.25	159	2.75	70	10.00	254
UFCO	2.15	54.5	0.84	1.25	7.50	191	2.76	70	9.84	250
UFCO	2.15	54.5	0.81	1.20	7.50	191	2.76	70	9.84	250
AFBX0	1.96	49.8	0.47	0.70	8.00	203	2.36	60	11.61	295
AFCX0	1.96	49.8	0.71	1.06	8.00	203	2.36	60	11.61	295
400H	2.19	55.6	1.78	2.65	8.00	203	3.75	95	13.00	330
461 / 861	2.09	53.1	0.83	1.24	7.75	197	3.00	76	14.00	356
AFBX1	2.03	51.6	0.85	1.26	8.00	203	5.12	130	11.61	295
AFCX1	2.03	51.6	1.09	1.62	8.00	203	5.12	130	11.61	295
UFBX1	1.95	49.5	0.94	1.40	6.25	159	5.00	127	10.00	254
401M	2.27	57.7	1.85	2.75	7.50	191	3.75	95	12.00	305
401H	2.27	57.7	2.10	3.13	8.00	203	3.75	95	13.00	330
UFBX1	1.96	49.8	1.09	1.62	6.25	159	5.00	127	10.00	254
462 / 862	2.16	54.9	1.07	1.59	7.75	197	3.00	76	14.00	356
UFC1	2.23	56.7	1.34	1.99	7.50	191	5.00	127	9.84	250
UFC1	2.23	56.7	1.28	1.90	7.50	191	5.00	127	9.84	250
UFBX2	2.05	52.1	1.43	2.13	6.25	159	5.00	127	10.00	254
AFBX2	2.10	53.3	1.23	1.83	8.00	203	5.12	130	11.61	295
AFCX2	2.10	53.3	1.47	2.19	8.00	203	5.12	130	11.61	295
402M	2.35	59.7	2.20	3.27	7.50	191	3.75	95	12.00	305
402H	2.35	59.7	2.50	3.72	8.00	203	3.75	95	13.00	330
UFC2	2.31	58.8	1.83	2.73	7.50	191	5.00	127	9.84	250
UFC2	2.31	58.8	1.81	2.70	7.50	191	5.00	127	9.84	250
UFBX2	2.05	52.1	1.58	2.35	6.25	159	5.00	127	10.00	254
402X	2.41	61.2	3.62	5.39	10.00	254	8.00	203	19.50	495
RF67	2.54	64.5	6.63	9.87	14.00	356	12.00	305	41.00	1041
SPECIALTY ALLOYS										
A400	2.18	55.4	1.97	2.93	8.00	203	3.75	95	13.00	330
A400-1	2.29	58.2	2.55	3.79	8.00	203	3.75	95	13.00	330
A400-2	2.39	60.7	3.16	4.70	8.00	203	3.75	95	13.00	330
A625	2.19	55.6	0.93	1.38	7.50	191	3.75	95	12.00	305
A625-1	2.27	57.7	1.27	1.89	7.50	191	3.75	95	12.00	305
A276	2.19	55.6	1.59	2.37	7.50	191	3.75	95	12.00	305
A276-1	2.27	57.7	1.97	2.93	7.50	191	3.75	95	12.00	305

2" (50mm) Metal Hose Pressure Ratings

T-321 & T-316L STAINLESS STEEL									
Hose Type	Hose Alloy	Braid		Full Vacuum to Maximum Pressure (at 70° F/21°C)					
				Working		Test		Burst	
		Layers	Alloy	psi	bar	psi	bar	psi	bar
UFBX0	T-321	-	-	15	1.0	23	1.6	-	-
UFBX0	T-316L	-	-	15	1.0	23	1.6	-	-
AFBX0	T-321/T-316	-	-	15	1.0	23	1.6	-	-
AFCX0	T-321/T-316L	-	-	15	1.0	23	1.6	-	-
UFCO	T-321	-	-	15	1.0	22	1.5	-	-
UFCO	T-316	-	-	15	1.0	22	1.5	-	-
400M	T-321	-	-	17	1.2	26	1.8	-	-
400H	T-316L	-	-	23	1.6	34	2.3	-	-
AFBX1	T-321/T-316	1	300 Series	425	29.3	638	44.0	1700	117.2
AFCX1	T-321/T-316L	1	300 Series	425	29.3	638	44.0	1700	117.2
401M	T-321	1	T-321	450	31.0	675	46.5	1800	124.1
401H	T-316L	1	T-321	450	31.0	675	46.5	1800	124.1
UFBX1	T-321	1	300 Series	478	33.0	717	49.4	1912	131.8
UFBX1	T-316L	1	300 Series	478	33.0	717	49.4	1912	131.8
UFC1	T-321	1	300 Series	583	40.2	875	60.3	2332	160.8
UFC1	T-316	1	300 Series	583	40.2	875	60.3	2332	160.8
AFBX2	T-321/T-316	2	300 Series	600	41.4	900	62.1	2400	165.5
AFCX2	T-321/T-316L	2	300 Series	600	41.4	900	62.1	2400	165.5
UFBX2	T-321	2	300 Series	638	44.0	957	66.0	2552	176.0
UFC2	T-321	2	300 Series	725	50.0	1088	75.0	2900	199.9
UFC2	T-316	2	300 Series	725	50.0	1088	75.0	2900	199.9
402M	T-321	2	T-321	810	55.8	1215	83.8	3240	223.4
402H	T-316L	2	T-321	810	55.8	1215	83.8	3240	223.4
UFBX2	T-316L	2	300 Series	870	60.0	1305	90.0	3480	239.9
402X	T-316L	2	T-321	1675	115.5	2512	173.2	6700	461.9
RF67	T-321	4	T-321	4350*	299.9*	6525	449.9	-	-
SPECIALTY ALLOYS									
A400	Monel®	-	-	20	1.4	30	2.1	-	-
A400-1	Monel®	1	Monel®	415	28.6	620	42.7	1660	114.5
A400-2	Monel®	2	Monel®	745	51.4	1015	70.0	2985	205.8
A625	Inconel® 625	-	-	14	1.0	21	1.4	-	-
A625-1	Inconel® 625	1	T-321 or 625	460	31.7	675	46.5	1800	124.1
A276	Hastelloy® C276	-	-	17	1.2	26	1.8	-	-
A276-1	Hastelloy® C276	1	300 or C276	470	32.4	705	48.6	1880	129.6

*Available Only as a US Factory welded assembly. Contact US Hose Corp for specific advice on pressure capabilities, testing, compatibilities and motion requirements as this product is unique.

2" (50mm) Metal Hose Technical Data

T-321 & T-316L STAINLESS STEEL										
Hose Type	Hose OD		Weight Per		Min. Live Length for Vibration		Min. Bend Radius			
							Static		Dynamic	
	in	mm	lb/ft	kg/m	in	mm	in	mm	in	mm
UFBX0	2.45	62.2	0.55	0.82	7.50	191	3.50	89	14.00	356
UFBX0	2.43	61.7	0.77	1.15	7.50	191	3.50	89	14.00	356
AFBX0	2.38	60.5	0.60	0.89	9.50	241	2.76	70	12.60	320
AFCX0	2.38	60.5	0.90	1.34	9.50	241	2.76	70	12.60	320
UFCO	2.59	65.7	0.92	1.37	9.00	229	3.54	90	13.78	350
UFCO	2.59	65.7	0.87	1.30	9.50	241	3.54	90	13.78	350
400M	2.83	71.9	1.97	2.93	9.00	229	5.00	127	15.00	381
400H	2.83	71.9	2.38	3.54	9.50	241	5.00	127	16.00	406
AFBX1	2.44	62.0	1.06	1.58	9.50	241	6.30	160	12.60	320
AFCX1	2.44	62.0	1.36	2.02	9.50	241	6.30	160	12.60	320
401M	2.91	73.9	2.44	3.63	9.00	229	5.00	127	15.00	381
401H	2.91	73.9	2.84	4.23	9.50	241	5.00	127	16.00	406
UFBX1	2.53	64.3	1.00	1.49	7.50	191	7.63	194	14.00	356
UFBX1	2.53	64.3	1.25	1.86	7.50	191	7.00	178	14.00	356
UFC1	2.69	68.4	1.59	2.36	9.00	229	6.89	175	13.78	350
UFC1	2.69	68.4	1.55	2.30	9.50	241	6.89	175	13.78	350
AFBX2	2.50	63.5	1.52	2.26	9.50	241	6.30	160	12.60	320
AFCX2	2.50	63.5	1.82	2.71	9.50	241	6.30	160	12.60	320
UFBX2	2.61	66.3	1.50	2.23	7.50	191	7.63	194	14.00	356
UFC2	2.79	70.9	2.25	3.35	9.00	229	6.89	175	13.78	350
UFC2	2.79	70.9	2.22	3.30	9.50	241	6.89	175	13.78	350
402M	2.99	75.9	2.90	4.32	9.00	229	5.00	127	15.00	381
402H	2.99	75.9	3.38	5.03	9.50	241	5.00	127	16.00	406
UFBX2	2.63	66.8	1.75	2.60	7.50	191	7.00	178	14.00	356
402X	3.05	77.5	4.63	6.89	12.00	305	11.50	292	24.00	610
RF67	3.04	77.2	8.07	12.01	18.00	457	15.00	381	48.00	1219
SPECIALTY ALLOYS										
A400	2.83	71.9	2.63	3.91	9.50	241	5.00	127	16.00	406
A400-1	2.93	74.4	3.37	5.02	9.50	241	5.00	127	16.00	406
A400-2	3.03	77.0	4.11	6.12	9.50	241	5.00	127	16.00	406
A625	2.72	69.1	1.23	1.83	7.75	197	5.00	127	15.00	381
A625-1	2.80	71.1	1.68	2.50	7.75	197	5.00	127	15.00	381
A276	2.83	71.9	2.08	3.10	9.00	229	5.00	127	15.00	381
A276-1	2.91	73.9	2.55	3.79	9.00	229	5.00	127	15.00	381

2 1/2" (65mm) Metal Hose Pressure Ratings

T-321 & T-316L STAINLESS STEEL									
Hose Type	Hose Alloy	Braid		Full Vacuum to Maximum Pressure (at 70° F/21°C)					
				Working		Test		Burst	
		Layers	Alloy	psi	bar	psi	bar	psi	bar
400M	T-321	-	-	7	0.5	10	0.7	-	-
400H	T-316L	-	-	14	1.0	20	1.4	-	-
UFBX0	T-321	-	-	15	1.0	23	1.6	-	-
UFBX0	T-316L	-	-	15	1.0	23	1.6	-	-
UFC0	T-321	-	-	15	1.0	22	1.5	-	-
UFC0	T-316	-	-	15	1.0	22	1.5	-	-
AFBX1	T-316	1	300 Series	348	24.0	522	36.0	1392	96.0
UFBX1	T-321	1	300 Series	377	26.0	566	39.0	1508	104.0
UFBX1	T-316L	1	300 Series	377	26.0	566	39.0	1508	104.0
UFC1	T-321	1	300 Series	486	33.5	729	50.3	1944	134.0
UFC1	T-316	1	300 Series	486	33.5	729	50.3	1944	134.0
AFBX2	T-316	2	300 Series	557	38.4	835	57.6	2228	153.6
401M	T-321	1	T-321	570	39.3	855	59.0	2280	157.2
401H	T-316L	1	T-321	570	39.3	855	59.0	2280	157.2
UFBX2	T-321	2	300 Series	667	46.0	1001	69.0	2668	184.0
UFBX2	T-316L	2	300 Series	667	46.0	1001	69.0	2668	184.0
UFC2	T-321	2	300 Series	725	50.0	1088	75.0	2900	199.9
UFC2	T-316	2	300 Series	725	50.0	1088	75.0	2900	199.9
402M	T-321	2	T-321	750	51.7	1125	77.6	3000	206.8
402H	T-316L	2	T-321	1030	71.0	1545	106.5	4120	284.1
SPECIALTY ALLOYS									
A625	Inconel® 625	-	-	7	0.5	10	0.7	-	-
A625-1	Inconel® 625	1	T-321 or 625	545	37.6	815	56.2	2180	150.3
A276	Hastelloy® C276	-	-	7	0.5	10	0.7	-	-
A276-1	Hastelloy® C276	1	300 or C276	545	37.6	815	56.2	2180	150.3

2 1/2" (65mm) Metal Hose Technical Data

T-321 & T-316L STAINLESS STEEL										
Hose Type	Hose OD		Weight Per		Min. Live Length for Vibration		Min. Bend Radius			
							Static		Dynamic	
	in	mm	lb/ft	kg/m	in	mm	in	mm	in	mm
400M	3.00	76.2	1.42	2.11	7.00	178	7.00	178	14.00	356
400H	3.00	76.2	2.06	3.07	7.75	197	7.00	178	17.00	432
UFBX0	3.01	76.5	1.30	1.93	7.50	191	4.50	114	16.00	406
UFBX0	3.01	76.5	1.30	1.93	7.50	191	4.50	114	16.00	406
UFCO	3.37	85.5	1.34	2.00	7.00	178	4.33	110	16.14	410
UFCO	3.37	85.5	1.34	2.00	7.00	178	4.33	110	16.14	410
AFBX1	3.27	83.0	1.77	2.64	7.50	191	7.09	180	16.14	410
UFBX1	3.09	78.5	1.90	2.83	7.50	191	7.90	201	16.00	406
UFBX1	3.09	78.5	1.90	2.83	7.50	191	7.90	201	16.00	406
UFC1	3.47	88.2	2.22	3.30	7.00	178	7.87	200	16.14	410
UFC1	3.47	88.2	2.22	3.30	7.00	178	7.87	200	16.14	410
AFBX2	3.37	85.5	2.86	4.25	7.50	191	7.09	180	16.14	410
401M	3.12	79.2	2.19	3.26	7.00	178	7.00	178	14.00	356
401H	3.12	79.2	2.83	4.21	7.75	197	7.00	178	17.00	432
UFBX2	3.18	80.8	2.50	3.72	7.50	191	7.90	201	16.00	406
UFBX2	3.18	80.8	2.50	3.72	7.50	191	7.90	201	16.00	406
UFC2	3.57	90.7	3.09	4.60	7.00	178	7.87	200	16.14	410
UFC2	3.57	90.7	3.09	4.60	7.00	178	7.87	200	16.14	410
402M	3.24	82.3	2.96	4.40	7.00	178	7.00	178	14.00	356
402H	3.24	82.3	3.74	5.57	7.75	197	7.00	178	17.00	432
SPECIALTY ALLOYS										
A625	3.11	79.0	1.08	1.61	11.00	279	7.00	178	16.00	406
A625-1	3.23	82.0	1.87	2.78	11.00	279	7.00	178	16.00	406
A276	3.11	79	1.10	1.64	11.00	279	7.00	178	16.00	406
A276-1	3.23	82.0	2.00	2.98	11.0	279	7.00	178	16.00	406

3" (80mm) Metal Hose Pressure Ratings

T-321 & T-316L STAINLESS STEEL									
Hose Type	Hose Alloy	Braid		Full Vacuum to Maximum Pressure (at 70° F/21°C)					
				Working		Test		Burst	
		Layers	Alloy	psi	bar	psi	bar	psi	bar
UFBX0	T-321	-	-	4	0.3	6	0.4	-	-
UFBX0	T-316L	-	-	4	0.3	6	0.4	-	-
400M	T-321	-	-	5	0.3	7	0.5	-	-
400H	T-316L	-	-	9	0.6	14	1.0	-	-
UFC0	T-321	-	-	15	1.0	22	1.5	-	-
UFC0	T-316	-	-	15	1.0	22	1.5	-	-
AFBX1	T-316	1	300 Series	290	20.0	435	30.0	1160	80.0
UFBX1	T-321	1	300 Series	375	25.9	560	38.6	1500	103.4
UFBX1	T-316L	1	300 Series	375	25.9	560	38.6	1500	103.4
UFC1	T-321	1	300 Series	408	28.1	611	42.1	1632	112.5
UFC1	T-316	1	300 Series	408	28.1	611	42.1	1632	112.5
401M	T-321	1	T-321	450	31.0	675	46.5	1800	124.1
401H	T-316L	1	T-321	450	31.0	675	46.5	1800	124.1
AFBX2	T-316	2	300 Series	464	32.0	696	48.0	1856	128.0
UFBX2	T-321	2	300 Series	550	37.9	825	56.9	2200	151.7
UFBX2	T-316L	2	300 Series	550	37.9	825	56.9	2200	151.7
402M	T-321	2	T-321	560	38.6	840	57.9	2240	154.4
UFC2	T-321	2	300 Series	725	50.0	1088	75.0	2900	199.9
UFC2	T-316	2	300 Series	725	50.0	1088	75.0	2900	199.9
402H	T-316L	2	T-321	820	56.5	1230	84.8	3280	226.1
403X	T-316L	3	T-321	1200	82.7	1800	124.1	4800	330.9
RF67	T-321	5	T-321	3000*	206.8*	4500	310.3	-	-
SPECIALTY ALLOYS									
A625	Inconel® 625	-	-	5	0.3	7.5	0.5	-	-
A625-1	Inconel® 625	1	T-321 or 625	440	30.3	660	45.5	1760	121.3
A276	Hastelloy® C276	-	-	5	0.3	7.5	0.5	-	-
A276-1	Hastelloy® C276	1	300 or C276	440	30.3	660	45.52	1760	121.3

*Available Only as a US Factory welded assembly. Contact US Hose Corp for specific advice on pressure capabilities, testing, compatibilities and motion requirements as this product is unique.

3" (80mm) Metal Hose Technical Data

T-321 & T-316L STAINLESS STEEL										
Hose Type	Hose OD		Weight Per		Min. Live Length for Vibration		Min. Bend Radius			
							Static		Dynamic	
	in	mm	lb/ft	kg/m	in	mm	in	mm	in	mm
UFBX0	3.57	90.7	1.35	2.01	11.00	279	8.25	210	19.00	483
UFBX0	3.57	90.7	1.35	2.01	11.00	279	8.25	210	19.00	483
400M	3.57	90.7	1.82	2.71	8.00	203	8.25	210	17.00	432
400H	3.57	90.7	2.44	3.63	9.00	229	8.25	210	21.00	533
UFCO	3.85	97.7	1.68	2.50	8.00	203	5.12	130	17.72	450
UFCO	3.85	97.7	1.68	2.50	8.00	203	5.12	130	17.72	450
AFBX1	3.86	98.0	1.90	2.83		0	7.87	200	17.72	450
UFBX1	3.69	93.7	1.83	2.72	11.00	279	8.25	210	19.00	483
UFBX1	3.69	93.7	2.78	4.14	11.00	279	8.25	210	19.00	483
UFC1	3.94	100.0	2.69	4.00	8.00	203	7.87	200	17.72	450
UFC1	3.94	100.0	2.69	4.00	8.00	203	7.87	200	17.72	450
401M	3.69	93.7	2.70	4.02	8.00	203	8.25	210	17.00	432
401H	3.69	93.7	3.32	4.94	9.00	229	8.25	210	21.00	533
AFBX2	3.96	100.5	3.02	4.50		0	7.87	200	17.72	450
UFBX2	3.76	95.5	2.57	3.82	11.00	279	8.25	210	19.00	483
UFBX2	3.76	95.5	4.21	6.27	11.00	279	8.25	210	19.00	483
402M	3.81	96.8	3.58	5.33	8.00	203	8.25	210	17.00	432
UFC2	4.06	103.0	3.70	5.50	8.00	203	7.87	200	17.72	450
UFC2	4.06	103.0	3.70	5.50	8.00	203	7.87	200	17.72	450
402H	3.81	96.8	4.30	6.40	9.00	229	8.25	210	21.00	533
403X	3.94	100.1	5.47	8.14	15.00	381	25.00	635	86.00	2184
RF67	4.06	103.1	14.41	21.44	24.00	610	25.00	635	65.00	1651
SPECIALTY ALLOYS										
A625	3.57	90.7	1.07	1.59	9.00	229	8.25	210	17.00	432
A625-1	3.69	93.7	1.93	2.87	9.00	229	8.25	210	17.00	432
A276	3.57	90.7	1.10	1.64	9.00	229	8.25	210	17.00	432
A276-1	3.69	93.7	2.05	2.92	9.00	229	8.25	210	17.00	432

3 1/2" (90mm) Metal Hose Pressure Ratings

T-321 & T-316L STAINLESS STEEL									
Hose Type	Hose Alloy	Braid		Full Vacuum to Maximum Pressure (at 70° F/21°C)					
				Working		Test		Burst	
		Layers	Alloy	psi	bar	psi	bar	psi	bar
UFBX0	T-321	-	-	3	0.2	4	0.3	-	-
UFBX0	T-316L	-	-	3	0.2	4	0.3	-	-
400M	T-321	-	-	3	0.2	5	0.3	-	-
400H	T-316L	-	-	7	0.5	10	0.7	-	-
UFBX1	T-321	1	300 Series	340	23.4	510	35.2	1360	93.8
UFBX1	T-316L	1	300 Series	340	23.4	510	35.2	1360	93.8
401H	T-316L	1	T-321	340	23.4	510	35.2	1360	93.8
401M	T-321	1	T-321	365	25.2	398	27.4	1060	73.1
402M	T-321	2	T-321	365	25.2	398	27.4	1060	73.1
402H	T-316L	2	T-321	600	41.4	900	62.1	2400	165.5
UFBX2	T-316L	2	300 Series	620	42.7	930	64.1	2480	171.0

3 1/2" (90mm) Metal Hose Technical Data

T-321 & T-316L STAINLESS STEEL										
Hose Type	Hose OD		Weight Per		Min. Live Length for Vibration		Min. Bend Radius			
	in	mm	lb/ft	kg/m	in	mm	Static		Dynamic	
							in	mm	in	mm
UFBX0	4.14	105.2	1.69	2.51	11.50	292	9.75	248	20.50	521
UFBX0	4.14	105.2	1.69	2.51	11.50	292	9.75	248	20.50	521
400M	4.14	105.2	1.57	2.34	9.00	229	9.50	241	19.00	483
400H	4.14	105.2	2.95	4.39	10.00	254	9.50	241	25.00	635
UFBX1	4.26	108.2	1.91	2.84	11.50	292	9.75	248	20.50	521
UFBX1	4.26	108.2	2.54	3.78	11.50	292	9.75	248	20.50	521
401H	4.26	108.2	3.81	5.67	10.00	254	9.50	241	25.00	635
401M	4.26	108.2	2.43	3.62	9.00	229	9.50	241	19.00	483
402M	4.38	111.3	3.29	4.90	9.00	229	9.50	241	19.00	483
402H	4.38	111.3	4.67	6.95	10.00	254	9.50	241	25.00	635
UFBX2	4.48	113.8	3.40	5.06	11.50	292	9.75	248	20.50	521

4" (100mm) Metal Hose Pressure Ratings

T-321 & T-316L STAINLESS STEEL									
Hose Type	Hose Alloy	Braid		Full Vacuum to Maximum Pressure (at 70° F/21°C)					
				Working		Test		Burst	
		Layers	Alloy	psi	bar	psi	bar	psi	bar
UFBX0	T-321	-	-	2	0.1	3	0.2	-	-
UFBX0	T-316L	-	-	2	0.1	3	0.2	-	-
400M	T-321	-	-	2	0.1	3	0.2	-	-
400H	T-316L	-	-	4	0.3	6	0.4	-	-
UFC0	T-321	-	-	10	0.7	15	1.0	-	-
UFC0	T-316	-	-	10	0.7	15	1.0	-	-
UFBX1	T-321	1	300 Series	260	17.9	390	26.9	1050	72.4
UFBX1	T-316L	1	300 Series	260	17.9	390	26.9	1050	72.4
AFBX1	T-316	1	300 Series	261	18.0	392	27.0	1044	72.0
401M	T-321	1	T-321	285	19.7	425	29.3	1140	78.6
401H	T-316L	1	T-321	285	19.7	425	29.3	1140	78.6
UFC1	T-321	1	300 Series	312	21.5	468	32.3	1248	86.0
UFC1	T-316	1	300 Series	312	21.5	468	32.3	1248	86.0
402M	T-321	2	T-321	375	25.9	563	38.8	1500	103.4
AFBX2	T-316	2	300 Series	418	28.8	627	43.2	1672	115.3
UFBX2	T-321	2	300 Series	465	32.1	695	47.9	1860	128.2
UFBX2	T-316L	2	300 Series	465	32.1	695	47.9	1860	128.2
UFC2	T-321	2	300 Series	493	34.0	740	51.0	1972	136.0
UFC2	T-316	2	300 Series	493	34.0	740	51.0	1972	136.0
402H	T-316L	2	T-321	515	35.5	770	53.1	2060	142.0
404X	T-316L	4	T-321	1200	82.7	1800	124.1	4800	330.9
SPECIALTY ALLOYS									
A625	Inconel® 625	-	-	4	0.3	6	0.4	-	-
A625-1	Inconel® 625	1	T-321 or 625	270	18.6	405	27.9	1080	74.5
A276	Hastelloy® C276	-	-	4	0.3	6	0.4	-	-
A276-1	Hastelloy® C276	1	300 or C276	270	18.6	405	27.9	1080	74.5

4" (100mm) Metal Hose Technical Data

T-321 & T-316L STAINLESS STEEL										
Hose Type	Hose OD		Weight Per		Min. Live Length for Vibration		Min. Bend Radius			
							Static		Dynamic	
	in	mm	lb/ft	kg/m	in	mm	in	mm	in	mm
UFBX0	4.72	119.9	1.66	2.47	12.00	305	11.00	279	22.00	559
UFBX0	4.72	119.9	2.06	3.07	12.00	305	11.00	279	22.00	559
400M	4.72	119.9	2.38	3.54	10.00	254	11.00	279	22.00	559
400H	4.72	119.9	3.20	4.76	10.75	273	11.00	279	27.00	686
UFCO	5.00	127.0	2.02	3.00	10.00	254	7.87	200	22.05	560
UFCO	5.00	127.0	2.02	3.00	10.00	254	7.87	200	22.05	560
UFBX1	4.82	122.4	2.59	3.85	12.00	305	11.00	279	22.00	559
UFBX1	4.82	122.4	3.00	4.46	12.00	305	11.00	279	22.00	559
AFBX1	4.69	119.0	2.55	3.80		0	11.42	290	22.05	560
401M	4.84	122.9	3.34	4.97	10.00	254	11.00	279	22.00	559
401H	4.84	122.9	4.16	6.19	10.75	273	11.00	279	27.00	686
UFC1	5.08	129.0	3.29	4.90	10.00	254	9.06	230	22.05	560
UFC1	5.08	129.0	3.29	4.90	10.00	254	9.06	230	22.05	560
402M	4.96	126.0	4.30	6.40	10.00	254	11.00	279	22.00	559
AFBX2	4.78	121.5	3.90	5.80		0	11.42	290	22.05	560
UFBX2	4.91	124.7	3.52	5.24	12.00	305	11.00	279	22.00	559
UFBX2	4.91	124.7	3.94	5.86	12.00	305	11.00	279	22.00	559
UFC2	5.20	132.0	4.57	6.80	10.00	254	9.06	230	22.05	560
UFC2	5.20	132.0	4.57	6.80	10.00	254	9.06	230	22.05	560
402H	4.96	126.0	5.24	7.80	10.75	273	11.00	279	27.00	686
404X	5.20	132.1	9.19	13.68	17.00	432	33.00	838	114.00	2896
SPECIALTY ALLOYS										
A625	4.72	119.9	2.57	3.82	10.75	273	11.00	279	27.00	686
A625-1	4.84	122.9	3.53	5.25	10.75	273	11.00	279	27.00	686
A276	4.72	119.9	2.70	4.02	10.75	273	11.00	279	27.00	686
A276-1	4.84	122.9	3.68	5.48	10.75	273	11.00	279	27.00	686

5" (125mm) Metal Hose Pressure Ratings

T-321 & T-316L STAINLESS STEEL									
Hose Type	Hose Alloy	Braid		Full Vacuum to Maximum Pressure (at 70° F/21°C)					
				Working		Test		Burst	
		Layers	Alloy	psi	bar	psi	bar	psi	bar
UFBX0	T-321	-	-	3	0.2	4	0.3	-	-
UFBX0	T-316L	-	-	3	0.2	4	0.3	-	-
400M	T-321	-	-	3	0.2	4	0.3	-	-
UFC0	T-321	-	-	3	0.2	4	0.3	-	-
UFC0	T-316	-	-	3	0.2	4	0.3	-	-
400H	T-316L	-	-	4	0.3	6	0.4	-	-
AFBX1	T-316	1	300 Series	203	14.0	305	21.0	812	56.0
UFC1	T-321	1	300 Series	210	14.5	315	21.7	840	57.9
401M	T-321	1	T-321	265	18.3	400	27.6	1060	73.1
402M	T-321	2	T-321	265	18.3	400	27.6	1060	73.1
UFBX1	T-321	1	300 Series	290	20.0	435	30.0	1160	80.0
UFBX2	T-321	2	300 Series	308	21.2	462	31.9	1232	84.9
AFBX2	T-316	2	300 Series	325	22.4	487	33.6	1300	89.6
UFBX1	T-316L	1	300 Series	340	23.4	510	35.2	1360	93.8
401H	T-316L	1	T-321	350	24.1	525	36.2	1400	96.5
UFC1	T-316	1	300 Series	350	24.1	524	36.1	1400	96.5
UFC2	T-321	2	300 Series	377	26.0	566	39.0	1508	104.0
402H	T-316L	2	T-321	385	26.5	578	39.9	1540	106.2
UFC2	T-316	2	300 Series	385	26.5	578	39.9	1540	106.2
UFBX2	T-316L	2	300 Series	435	30.0	650	44.8	1740	120.0

5" (125mm) Metal Hose Technical Data

T-321 & T-316L STAINLESS STEEL										
Hose Type	Hose OD		Weight Per		Min. Live Length for Vibration		Min. Bend Radius			
	in	mm	lb/ft	kg/m	in	mm	Static		Dynamic	
							in	mm	in	mm
UFBX0	5.86	148.8	2.27	3.38	13.00	330	13.50	343	28.00	711
UFBX0	5.86	148.8	2.68	3.99	13.00	330	13.50	343	28.00	711
400M	5.93	150.6	3.20	4.76	17.50	445	11.00	279	28.00	711
UFCO	5.94	151.0	3.21	4.77	17.50	445	10.98	279	27.99	711
UFCO	5.94	151.0	3.21	4.77	17.50	445	10.98	279	27.99	711
400H	5.93	150.6	3.20	4.76	17.50	445	11.00	279	28.00	711
AFBX1	6.00	152.5	3.58	5.33		0	12.80	325	27.95	710
UFC1	6.02	153.0	4.48	6.67	17.50	445	10.98	279	27.99	711
401M	6.03	153.2	4.50	6.70	17.50	445	11.00	279	28.00	711
402M	6.13	155.7	5.80	8.63	17.50	445	11.00	279	28.00	711
UFBX1	5.96	151.4	3.57	5.31	13.00	330	13.50	343	28.00	711
UFBX2	6.06	153.9	4.87	7.25	13.00	330	13.50	343	28.00	711
AFBX2	6.10	155.0	5.44	8.10		0	12.80	325	27.95	710
UFBX1	5.96	151.4	3.98	5.92	13.00	330	13.50	343	28.00	711
401H	6.03	153.2	4.50	6.70	17.50	445	11.00	279	28.00	711
UFC1	6.02	153.0	4.48	6.67	17.50	445	10.98	279	27.99	711
UFC2	6.14	156.0	5.76	8.57	17.50	445	10.98	279	27.99	711
402H	6.13	155.7	5.80	8.63	17.50	445	11.00	279	28.00	711
UFC2	6.14	156.0	5.76	8.57	17.50	445	10.98	279	27.99	711
UFBX2	6.06	153.9	5.28	7.86	13.00	330	13.50	343	28.00	711

6" (150mm) Metal Hose Pressure Ratings

T-321 & T-316L STAINLESS STEEL									
Hose Type	Hose Alloy	Braid		Full Vacuum to Maximum Pressure (at 70° F/21°C)					
				Working		Test		Burst	
		Layers	Alloy	psi	bar	psi	bar	psi	bar
UFBX0	T-321	-	-	3	0.2	4	0.3	-	-
UFBX0	T-316L	-	-	3	0.2	4	0.3	-	-
400M	T-321	-	-	4	0.3	5	0.3	-	-
UFC0	T-321	-	-	4	0.3	5	0.3	-	-
UFC0	T-316	-	-	4	0.3	5	0.3	-	-
400H	T-316L	-	-	7	0.5	9	0.6	-	-
AFBX1	T-316	1	300 Series	181	12.5	272	18.8	724	49.9
UFBX1	T-321	1	300 Series	210	14.5	315	21.7	850	58.6
UFBX1	T-316L	1	300 Series	210	14.5	315	21.7	850	58.6
401M	T-321	1	T-321	240	16.5	360	24.8	960	66.2
401H	T-316L	1	T-321	240	16.5	360	24.8	960	66.2
UFC1	T-321	1	300 Series	240	16.5	360	24.8	960	66.2
UFC1	T-316	1	300 Series	240	16.5	360	24.8	960	66.2
402M	T-321	2	T-321	285	19.7	428	29.5	1140	78.6
UFC2	T-321	2	300 Series	285	19.7	428	29.5	1140	78.6
AFBX2	T-316	2	300 Series	290	20.0	435	30.0	1160	80.0
UFBX2	T-321	2	300 Series	310	21.4	465	32.1	1240	85.5
UFBX2	T-316L	2	300 Series	310	21.4	465	32.1	1240	85.5
402H	T-316L	2	T-321	430	29.6	645	44.5	1720	118.6
UFC2	T-316	2	300 Series	430	29.6	644	44.4	1720	118.6

6" (150mm) Metal Hose Technical Data

T-321 & T-316L STAINLESS STEEL										
Hose Type	Hose OD		Weight Per		Min. Live Length for Vibration		Min. Bend Radius			
							Static		Dynamic	
	in	mm	lb/ft	kg/m	in	mm	in	mm	in	mm
UFBX0	7.00	177.8	3.53	5.25	14.00	356	16.00	406	34.00	864
UFBX0	7.00	177.8	4.44	6.61	14.00	356	16.00	406	34.00	864
400M	7.00	177.8	4.46	6.64	17.00	432	16.50	419	33.00	838
UFCO	7.01	178.0	4.47	6.65	17.00	432	16.50	419	32.99	838
UFCO	7.01	178.0	5.58	8.31	19.00	483	16.50	419	32.99	838
400H	7.00	177.8	5.58	8.30	19.00	483	16.50	419	41.00	1041
AFBX1	7.01	178.0	4.55	6.77		0	14.96	380	32.09	815
UFBX1	7.10	180.3	5.22	7.77	14.00	356	16.00	406	34.00	864
UFBX1	7.10	180.3	6.14	9.14	14.00	356	16.00	406	34.00	864
401M	7.19	182.6	6.20	9.23	17.00	432	16.50	419	33.00	838
401H	7.19	182.6	7.32	10.89	19.00	483	16.50	419	41.00	1041
UFC1	7.09	180.0	6.28	9.35	17.00	432	16.50	419	32.99	838
UFC1	7.09	180.0	6.59	9.81	19.00	483	16.50	419	32.99	838
402M	7.38	187.5	7.94	11.82	17.00	432	16.50	419	33.00	838
UFC2	7.20	183.0	8.10	12.05	17.00	432	16.50	419	32.99	838
AFBX2	7.13	181.0	6.91	10.29		0	14.96	380	32.09	815
UFBX2	7.19	182.6	6.91	10.28	14.00	356	16.00	406	34.00	864
UFBX2	7.19	182.6	7.78	11.58	14.00	356	16.00	406	34.00	864
402H	7.38	187.5	9.06	13.48	19.00	483	16.50	419	41.00	1041
UFC2	7.20	183.0	7.59	11.30	19.00	483	16.50	419	32.99	838

8" (200mm) Metal Hose Pressure Ratings

T-321 & T-316L STAINLESS STEEL									
Hose Type	Hose Alloy	Braid		Full Vacuum to Maximum Pressure (at 70° F/21°C)					
				Working		Test		Burst	
		Layers	Alloy	psi	bar	psi	bar	psi	bar
UFBX0	T-321	-	-	2	0.1	3	0.2	-	-
UFBX0	T-316L	-	-	2	0.1	3	0.2	-	-
400M	T-321	-	-	3	0.2	4	0.3	-	-
UFC0	T-321	-	-	3	0.2	4	0.3	-	-
UFC0	T-316	-	-	3	0.2	4	0.3	-	-
400H	T-316L	-	-	5	0.3	8	0.6	-	-
AFBX1	T-316	1	300 Series	116	8.0	174	12.0	464	32.0
AFBX2	T-316	2	300 Series	186	12.8	278	19.2	744	51.3
401M	T-321	1	T-321	217	15.0	326	22.5	868	59.8
UFC1	T-321	1	300 Series	217	15.0	326	22.5	868	59.8
UFBX1	T-321	1	300 Series	220	15.2	330	22.8	875	60.3
UFBX1	T-316L	1	300 Series	220	15.2	330	22.8	875	60.3
402M	T-321	2	T-321	270	18.6	405	27.9	1080	74.5
UFC2	T-321	2	300 Series	270	18.6	405	27.9	1080	74.5
401H	T-316L	1	T-321	275	19.0	410	28.3	1100	75.8
UFC1	T-316	1	300 Series	275	19.0	413	28.5	1100	75.8
UFBX2	T-321	2	300 Series	340	23.4	510	35.2	1360	93.8
UFBX2	T-316L	2	300 Series	340	23.4	510	35.2	1360	93.8
402H	T-316L	2	T-321	350	24.1	525	36.2	1400	96.5
UFC2	T-316	2	300 Series	350	24.1	525	36.2	1400	96.5

8" (200mm) Metal Hose Technical Data

T-321 & T-316L STAINLESS STEEL										
Hose Type	Hose OD		Weight Per		Min. Live Length for Vibration		Min. Bend Radius			
							Static		Dynamic	
	in	mm	lb/ft	kg/m	in	mm	in	mm	in	mm
UFBX0	9.06	230.1	4.59	6.83	16.00	406	20.00	508	42.00	1067
UFBX0	9.06	230.1	5.70	8.48	16.00	406	20.00	508	42.00	1067
400M	9.06	230.1	5.85	8.71	19.00	483	21.50	546	43.00	1092
UFCO	9.06	230.0	5.86	8.72	19.00	483	21.50	546	42.99	1092
UFCO	9.06	230.0	7.38	10.98	19.00	483	21.50	546	42.99	1092
400H	9.06	230.1	7.37	10.97	21.00	533	21.50	546	54.00	1372
AFBX1	8.98	228.0	6.56	9.76		0	19.69	500	39.96	1015
AFBX2	9.09	231.0	9.74	14.50		0	19.69	500	39.96	1015
401M	9.31	236.5	9.39	13.97	19.00	483	21.50	546	43.00	1092
UFC1	9.13	232.0	9.41	14.00	19.00	483	21.50	546	42.99	1092
UFBX1	9.16	232.7	7.91	11.77	16.00	406	20.00	508	42.00	1067
UFBX1	9.16	232.7	9.02	13.42	16.00	406	20.00	508	42.00	1067
402M	9.56	242.8	12.93	19.24	19.00	483	21.50	546	43.00	1092
UFC2	9.21	234.0	12.95	19.27	19.00	483	21.50	546	42.99	1092
401H	9.31	236.5	10.91	16.24	21.00	533	21.50	546	54.00	1372
UFC1	9.13	232.0	10.93	16.26	19.00	483	21.50	546	42.99	1092
UFBX2	9.26	235.2	11.23	16.71	16.00	406	20.00	508	42.00	1067
UFBX2	9.26	235.2	12.34	18.36	16.00	406	20.00	508	42.00	1067
402H	9.56	242.8	14.45	21.50	21.00	533	21.50	546	54.00	1372
UFC2	9.21	234.0	14.47	21.53	19.00	483	21.50	546	42.99	1092

10" (250mm) Metal Hose Pressure Ratings

T-321 & T-316L STAINLESS STEEL									
Hose Type	Hose Alloy	Braid		Full Vacuum to Maximum Pressure (at 70° F/21°C)					
				Working		Test		Burst	
		Layers	Alloy	psi	bar	psi	bar	psi	bar
UFBX0	T-321	-	-	2	0.1	3	0.2	-	-
UFBX0	T-316L	-	-	2	0.1	3	0.2	-	-
400M	T-321	-	-	2	0.1	3	0.2	-	-
400H	T-316L	-	-	2	0.1	3	0.2	-	-
UFC0	T-321	-	-	2	0.1	3	0.2	-	-
UFC0	T-316	-	-	2	0.1	3	0.2	-	-
AFBX1	T-316	1	300 Series	109	7.5	163	11.2	436	30.1
AFBX2	T-316	2	300 Series	174	12.0	261	18.0	696	48.0
UFBX1	T-321	1	300 Series	185	12.8	275	19.0	740	51.0
UFBX1	T-316L	1	300 Series	185	12.8	275	19.0	740	51.0
401M	T-321	1	T-321	210	14.5	315	21.7	840	57.9
UFC1	T-321	1	300 Series	210	14.5	315	21.7	840	57.9
401H	T-316L	1	T-321	250	17.2	375	25.9	1000	68.9
UFC1	T-316	1	300 Series	250	17.2	375	25.9	1000	68.9
UFBX2	T-321	2	300 Series	330	22.8	495	34.1	1320	91.0
UFBX2	T-316L	2	300 Series	330	22.8	495	34.1	1320	91.0
402M	T-321	2	T-321	375	25.9	563	38.8	1500	103.4
402H	T-316L	2	T-321	375	25.9	563	38.8	1500	103.4
UFC2	T-321	2	300 Series	375	25.9	563	38.8	1500	103.4
UFC2	T-316	2	300 Series	375	25.9	563	38.8	1500	103.4

10" (250mm) Metal Hose Technical Data

T-321 & T-316L STAINLESS STEEL										
Hose Type	Hose OD		Weight Per		Min. Live Length for Vibration		Min. Bend Radius			
							Static		Dynamic	
	in	mm	lb/ft	kg/m	in	mm	in	mm	in	mm
UFBX0	11.19	284.2	5.93	8.82	24.00	610	34.00	864	69.00	1753
UFBX0	11.19	284.2	5.93	8.82	24.00	610	34.00	864	69.00	1753
400M	11.19	284.2	9.17	13.65	21.00	533	27.00	686	54.00	1372
400H	11.19	284.2	8.29	12.34	27.00	686	34.00	864	68.00	1727
UFCO	11.18	284.0	9.18	13.66	21.00	533	27.01	686	54.02	1372
UFCO	11.18	284.0	8.30	12.35	21.00	533	27.01	686	54.02	1372
AFBX1	11.06	281.0	9.24	13.75		0	24.41	620	50.00	1270
AFBX2	11.18	284.0	13.80	20.54		0	24.41	620	50.00	1270
UFBX1	11.29	286.8	10.30	15.33	24.00	610	34.00	864	69.00	1753
UFBX1	11.29	286.8	10.30	15.33	24.00	610	34.00	864	69.00	1753
401M	11.44	290.6	13.54	20.15	21.00	533	27.00	686	54.00	1372
UFC1	11.38	289.0	13.55	20.17	21.00	533	27.01	686	54.02	1372
401H	11.44	290.6	12.66	18.84	27.00	686	34.00	864	68.00	1727
UFC1	11.38	289.0	12.67	18.86	21.00	533	27.01	686	54.02	1372
UFBX2	11.39	289.3	14.67	21.83	24.00	610	34.00	864	69.00	1753
UFBX2	11.39	289.3	14.67	21.83	24.00	610	34.00	864	69.00	1753
402M	11.69	296.9	17.91	26.65	21.00	533	27.00	686	54.00	1372
402H	11.69	296.9	17.03	25.34	27.00	686	34.00	864	68.00	1727
UFC2	11.57	294.0	17.93	26.69	21.00	533	27.01	686	54.02	1372
UFC2	11.57	294.0	17.05	25.37	21.00	533	27.01	686	54.02	1372

12" (300mm) Metal Hose Pressure Ratings

T-321 & T-316L STAINLESS STEEL									
Hose Type	Hose Alloy	Braid		Full Vacuum to Maximum Pressure (at 70° F/21°C)					
				Working		Test		Burst	
		Layers	Alloy	psi	bar	psi	bar	psi	bar
UFBX0	T-321	-	-	2	0.1	3	0.2	-	-
UFBX0	T-316L	-	-	2	0.1	3	0.2	-	-
400M	T-321	-	-	2	0.1	3	0.2	-	-
400H	T-316L	-	-	2	0.1	3	0.2	-	-
UFCO	T-321	-	-	2	0.1	3	0.2	-	-
UFCO	T-316	-	-	2	0.1	3	0.2	-	-
AFBX1	T-316	1	300 Series	87	6.0	131	9.0	348	24.0
AFBX2	T-316	2	300 Series	139	9.6	209	14.4	556	38.3
UFBX1	T-321	1	300 Series	175	12.1	260	17.9	700	48.3
UFBX1	T-316L	1	300 Series	175	12.1	260	17.9	700	48.3
401H	T-316L	1	T-321	180	12.4	270	18.6	720	49.6
UFC1	T-316	1	300 Series	180	12.4	270	18.6	720	49.6
401M	T-321	1	T-321	200	13.8	300	20.7	800	55.2
UFC1	T-321	1	300 Series	200	13.8	300	20.7	800	55.2
UFBX2	T-321	2	300 Series	315	21.7	470	32.4	1260	86.9
UFBX2	T-316L	2	300 Series	315	21.7	470	32.4	1260	86.9
402H	T-316L	2	T-321	320	22.1	480	33.1	1280	88.3
UFC2	T-316	2	300 Series	320	22.1	480	33.1	1280	88.3
402M	T-321	2	T-321	360	24.8	540	37.2	1440	99.3
UFC2	T-321	2	300 Series	360	24.8	540	37.2	1440	99.3

12" (300mm) Metal Hose Technical Data

T-321 & T-316L STAINLESS STEEL										
Hose Type	Hose OD		Weight Per		Min. Live Length for Vibration		Min. Bend Radius			
							Static		Dynamic	
	in	mm	lb/ft	kg/m	in	mm	in	mm	in	mm
UFBX0	13.25	336.6	7.08	10.54	27.00	686	37.00	940	74.00	1880
UFBX0	13.25	336.6	7.08	10.54	27.00	686	37.00	940	74.00	1880
400M	13.25	336.6	10.93	16.27	23.00	584	32.00	813	64.00	1626
400H	13.25	336.6	9.94	14.79	31.00	787	42.00	1067	83.00	2108
UFCO	13.27	337.0	10.95	16.29	23.00	584	32.01	813	64.02	1626
UFCO	13.27	337.0	9.95	14.81	23.00	584	32.01	813	64.02	1626
AFBX1	13.35	339.0	12.23	18.20		0	28.54	725	60.04	1525
AFBX2	13.46	342.0	17.32	25.78		0	28.54	725	60.04	1525
UFBX1	13.35	339.1	13.62	20.27	27.00	686	37.00	940	74.00	1880
UFBX1	13.35	339.1	13.62	20.27	27.00	686	37.00	940	74.00	1880
401H	13.45	341.6	16.48	24.52	31.00	787	42.00	1067	83.00	2108
UFC1	13.50	343.0	16.50	24.56	23.00	584	32.01	813	64.02	1626
401M	13.50	342.9	16.94	25.21	23.00	584	32.00	813	64.00	1626
UFC1	13.50	343.0	16.96	25.24	23.00	584	32.01	813	64.02	1626
UFBX2	13.45	341.6	20.16	30.00	27.00	686	37.00	940	74.00	1880
UFBX2	13.45	341.6	20.16	30.00	27.00	686	37.00	940	74.00	1880
402H	13.65	346.7	23.02	34.26	31.00	787	42.00	1067	83.00	2108
UFC2	13.74	349.0	23.05	34.30	23.00	584	32.01	813	64.02	1626
402M	13.75	349.3	22.95	34.15	23.00	584	32.00	813	64.00	1626
UFC2	13.74	349.0	22.98	34.20	23.00	584	32.01	813	64.02	1626

Interlocked Hose

Stripwound Hose:

Manufactured from a helically (spiral) wound and overlapping profiled strip in accordance with BS EN ISO 15465.

Standalone Applications:

Auto heater tubing, Ventilating ducting, Automotive exhaust, Moderate suction lines, Dust collecting Ducting, Refrigeration tubing armor, Air Blower ducting, Wiring conduit, Carburetor air intake, hot ash granulate

Metal Assembly Applications:

Metal assembly armor guard, flow liner and bend restrictors

Size Range:

3/16" to 6" I.D. (4.7mm - 152mm) inclusive. Larger sizes may be available - please contact the Factory for more information.

Metals:

Stainless Steel, Galvanized Steel, Brass, Bronze, and Monel

Metal Thickness:

0.010 inches - 0.012 inches (0.254mm - 0.305mm)

Temperature Ratings:

Galvanized Steel: Up to 392°F/200°C

T-304 Stainless Steel: Up to 850°F/454°C

Rigid Versus Floppy:

Rigid guard has a tighter profile to provide additional support in application where protection, bend restriction or high flow rates are critical. Floppy guards profile allows free movement of the hose assembly while providing protection to the hose and braid.

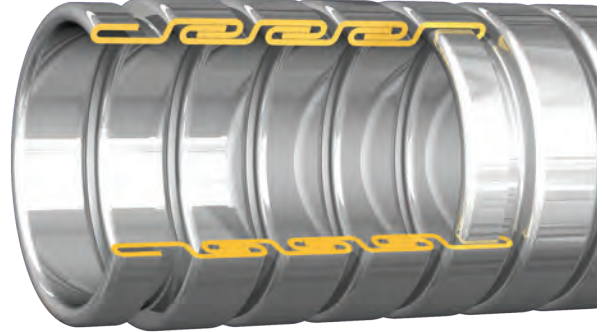

Polygonal Cross Section:

Polygonal profile provide better size stability when cut, especially on short lengths, due to the liner surfaces and bends locked together.

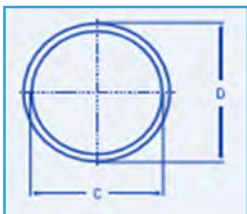

Lined/Smoothbore Cross Section:

This profile provides a smoother bore to the hose for higher velocity flow rates. Flow must be proper direction for maximum efficiency.

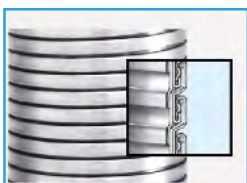

Rounded Cross Section:

Round profile is the most common guard used and provide excellent overall performance. The round profile can allow for minor adjustments in diameter by tightening or loosening the guard.

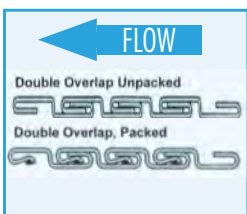

Unpacked Versus Packed:

Packing can be applied into the profile to provide a tighter seal against media escape in certain applications. This is done in rigid profiles and a variety of packing options are available.

Interlocked Hose (continued)

INTERLOCK® (ROUNDED)							
Nominal I.D.		Nominal O.D.		Minimum Inside Bend Diameter		Weight Per	
in	mm	in	mm	in	mm	lb/ft	kg/m
¾	19.1	0.90	22.9	4.7	120.0	0.27	0.40
1	25.4	1.19	30.2	5.5	140.0	0.67	1.00
1¼	31.8	1.44	36.6	7.3	185.0	0.74	1.10
1½	38.1	1.69	42.9	7.5	190.0	0.60	0.90
2	50.8	2.19	55.6	11.8	300.0	1.21	1.80
2½	63.5	2.69	68.3	13.0	330.0	1.55	2.30
3⅛	79.4	3.31	84.2	15.4	390.0	1.95	2.90
3¼	82.6	4.19	106.4	18.5	470.0	2.35	3.50
5	127.0	5.17	131.3	21.9	555.0	2.82	4.20
6	152.4	6.18	157.0	25.2	640.0	2.96	4.40
8	203.2	8.35	212.0	38.0	965.0	7.06	10.50
10	254.0	10.31	261.9	44.9	1140.0	6.85	10.20
12	304.8	12.31	312.7	53.1	1350.0	8.27	12.30

POLYLOCK® (POLYGONAL)							
Nominal I.D.		Nominal O.D.		Minimum Inside Bend Diameter		Weight Per	
in	mm	in	mm	in	mm	lb/ft	kg/m
1¼	31.8	1.43	36.2	6.50	165.0	0.46	0.69
1½	38.1	1.74	44.3	7.24	184.0	0.58	0.86
2	50.8	2.15	54.5	9.02	229.0	0.72	1.07
2½	63.5	2.74	69.5	12.24	311.0	0.94	1.40
3⅛	79.4	3.33	84.5	14.49	368.0	1.15	1.71
4	101.6	4.14	105.2	19.49	495.0	1.47	2.19
5	127.0	5.21	132.3	23.50	597.0	2.08	3.10
6	152.4	6.11	155.3	27.52	699.0	2.20	3.27
8	203.2	8.21	208.6	42.01	1067.0	4.37	6.50

PXPM® (LINED)							
Nominal I.D.		Nominal O.D.		Minimum Inside Bend Diameter		Weight Per	
in	mm	in	mm	in	mm	lb/ft	kg/m
3	76.2	3.19	81.0	16.1	410	1.95	2.90
4	101.6	4.25	108.0	21.3	540	2.49	3.70
5	127.0	5.24	133.0	27.6	700	3.12	4.65
6	152.4	0.06	1.6	31.5	800	3.76	5.60

*Specifications for other sizes not shown and are available on application

Assembly Customization

United Flexible offers a wide variety of options to modify assemblies for performance to meet the most demanding of applications or requirements.

Assembly Protection

Interlock Hose

A strip wound hose made of a helical profile of interlocked strip. This hose can be used as:

- Outer Protective Guard over the hose assembly to protect against physical damage to hose and braid layers
- Inner Protective Liner to protect hose from abrasive media or provide a smoother bore for increased media flow rates
- Bend Restrictor at assembly ends to provide support and prevent over bending

Rope Lagging

A helical wrapping of rope around the outside of the hose with a closed pitch to protect the hose and braid from physical damage and insulation on cryogenic applications. Rope materials and diameter can be varied to requirements.

Spring Guard

A helical wrapping wire around hose assembly to provide support and if attached to fittings can provide “whip” protection in case of rupture.

Silicone Fire Sleeve

Silicon impregnated Fiberglass sleeve to provide protection to hose and braid from high heat and environmental conditions.

Heat Shrink Covering

Heat shrink tubing placed over hose and shrunk tight against assembly to provide protection from minor environmental conditions. Materials and colors can be varied to meet desired performance and aesthetics.

Assembly Identification

United flexible offers a variety of identification option to provide identification, customer logo branding, serialization, operation limits, date stamping, etc...

- Laser printed/etched stainless steel tags, aluminum tags, or braid bands
- Dot peened stainless steel and aluminum tags
- Custom printed heat shrink bands in variety of colors and lengths

This is only a sampling of add-ons that are available...Challenge Us With Your Needs!!!

Assembly Customization (continued)

Cleaning

Cleaning options are available for assemblies to allow for use in critical services such as oxygen service and contamination sensitive applications. We offer cleaning services on assemblies that need to meet CGA requirements for Industrial oxygen and gas services. Precision Cleaning services are also available for aerospace and other mission critical applications.

Leak and Proof Testing

Safety is a top concern and making sure our assemblies meet critical applications requirements we 100% test all of our assemblies. United flexible offers a wide variety of testing services consisting of:

- Pneumatic bubble testing with compressed air, nitrogen or helium
- Hydrostatic proof testing to 1.5x working pressure with reverse osmosis water or de-ionized water upon request.
- Helium Mass spectrometer leak detection

Non-Destructive Testing (NDT)

A variety of nondestructive testing options are available and follow American Society for Nondestructive Testing (ASNT) recommended practice SNT-TC-1A:

- Dye Penetrant Testing (Visible and Fluorescent)
- X-Ray Fluorescence Positive Material Identification (XFR PMI)
- Radiographic Examination (X-Ray)

Certification

Certification records can be produced for all work and testing performed

- Certificated of Conformance (CoC)
- Certificates of Testing (CoT)
- Certificates of Testing w/ Chart Recorded Data (CoT)
- Certified Material Test Reports (CMTRs)
- Manufacturing Data Records (MDR Books)
- Acceptance Data Packages (ADP)
- Inspection and Testing Control Plans (ITPs)

When a prominent rocket provider to NASA needed a nimble and dynamic supplier for flexible solutions within their budget. They were looking beyond the usual suspects to find a more responsive, more affordable solution. So UF provided multiple reliable solutions that enabled them to continue being cost-effective.

Assembly Schematic

Basic Metallic Assembly

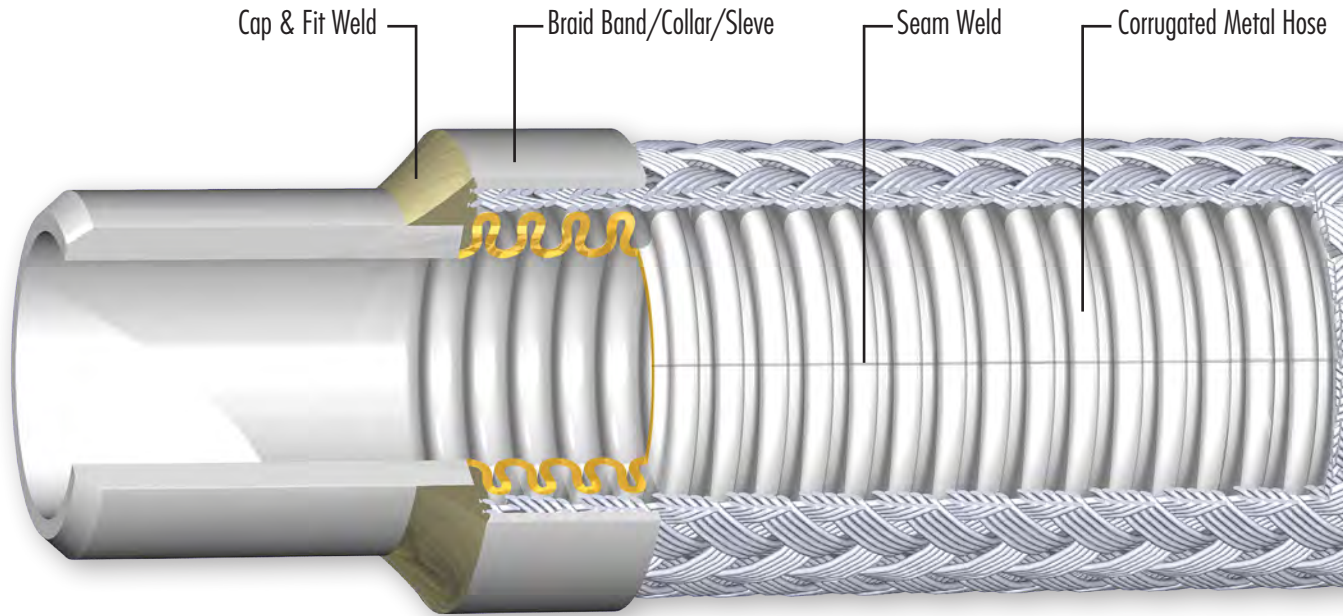

End Preparation

Corrugation Valley Cut

Standard end preparation providing wider cap weld for fitting attachment (Fluorescent)

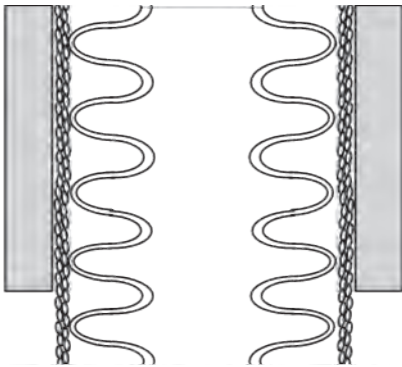

Corrugation Crest Cut

Special end preparation providing smoother assembly bore

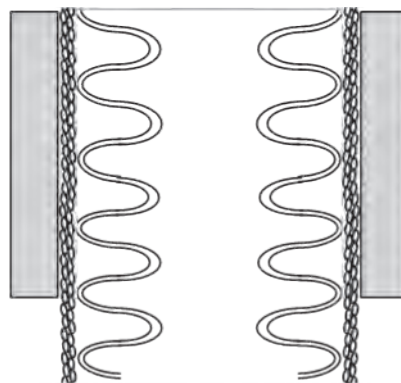

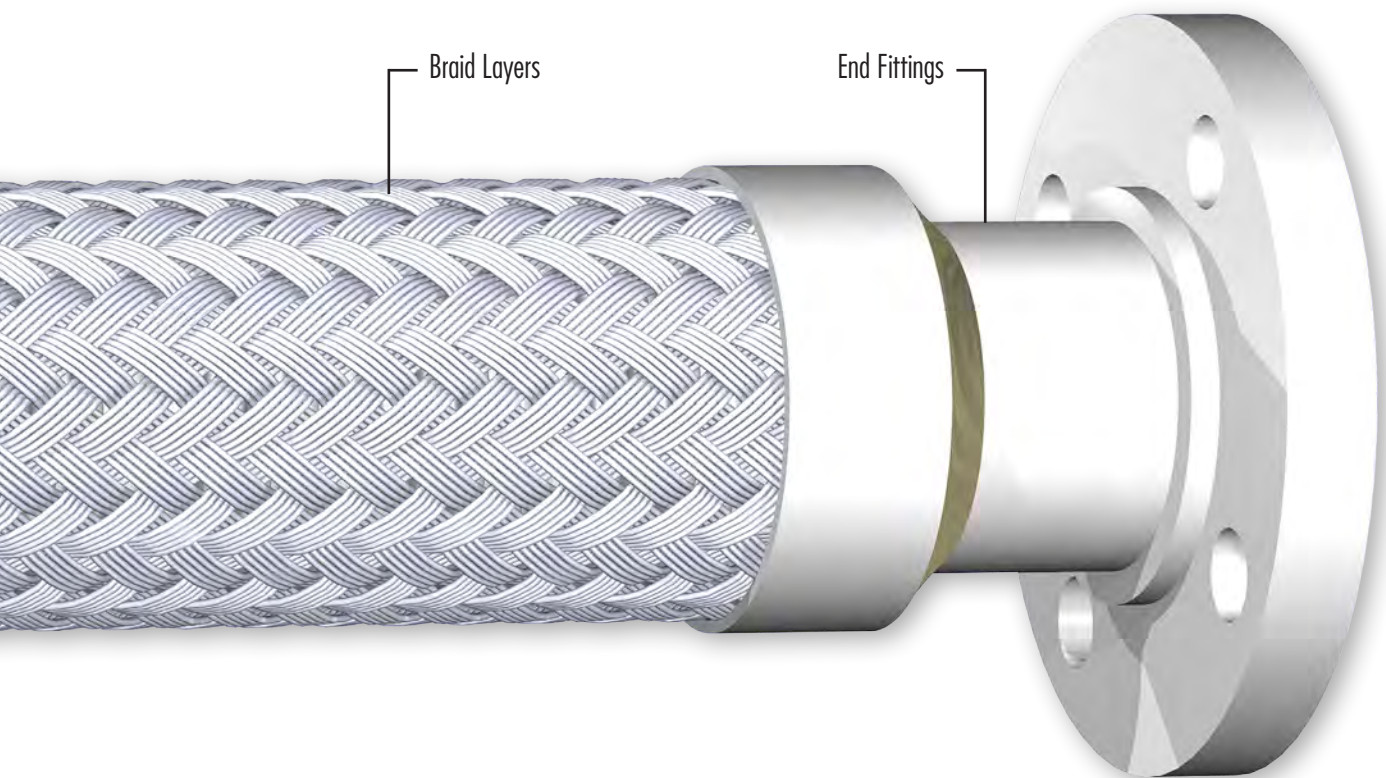

GTAW/TIG Welded Ends

**Method 1
Direct Fitting Attachment**

Welding Procedures as Required

ASME Boiler & Pressure Vessel Code

Section IX

AWS D17.1

EN 9606

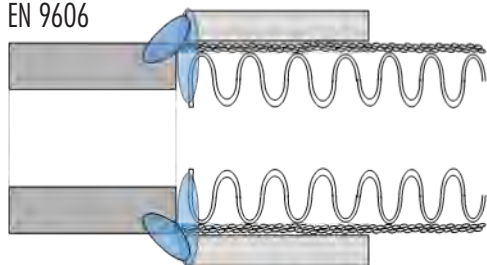

**Method 2
Braid Over/Neck Down**

Welding Procedures as Required

ASME Boiler & Pressure Vessel Code

Section IX

AWS D17.1

EN 9606

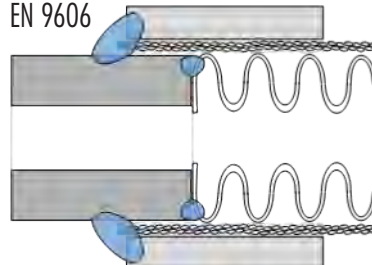

Installation Guide

To obtain maximum service life from metal hose, two **IMPORTANT** installation rules must be kept in mind:

1. Do Not Torque

A hose is subject to torque by:

Twisting in installation. To minimize possible torque damage to a hose, a union or floating flange should be used at one end of the hose assembly. Where flanges are used, the fixed flange end should be bolted into place before the floating flange end. Where a threaded nipple and a union are used, the nipple end should be threaded into place, and then the union tightened into place using two wrenches.

Twisting on fixture. Always install the hose so that flexing takes place in one plane only, and in the plane of bending.

2. Avoid Sharp Bends

There are many ways a hose can be subjected to recurring sharp bends as a result of improper installation. A few examples are illustrated below. The minimum centerline bend radius for dynamic flexing should never be less than the values specified in the Technical Data Section.

Should piping restrictions make it impractical to install hose in the proper manner, the use of interlocked hose guard will limit the hose bending to a suitable radius, thus prolonging the life of the corrugated hose.

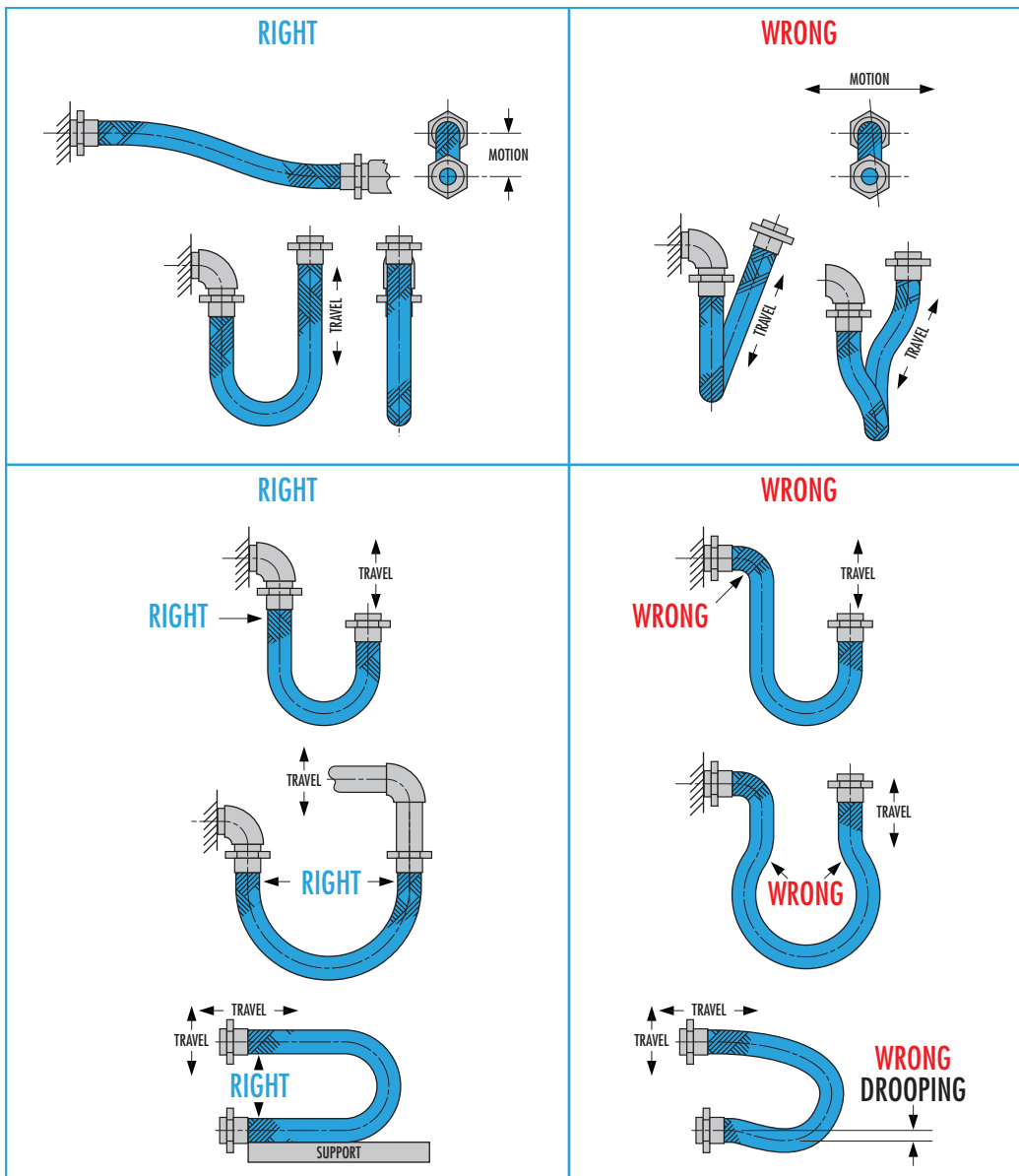

Installation Guide (continued)

Pipe Anchoring and Guiding

A piping system which utilizes flexible metal hose to absorb pipe movement must be properly anchored and guided to assure correct functioning and maximum service life of the metal hose. The basic principles to be observed are:

1. Pipe Motion

The direction of pipe motion must be perpendicular to the center line (axis) of the hose.

2. Anchoring

The pipe must be anchored at each change of direction where a flexible metal hose is employed to prevent torsional stress.

Typical examples of correct and incorrect guiding are shown below.

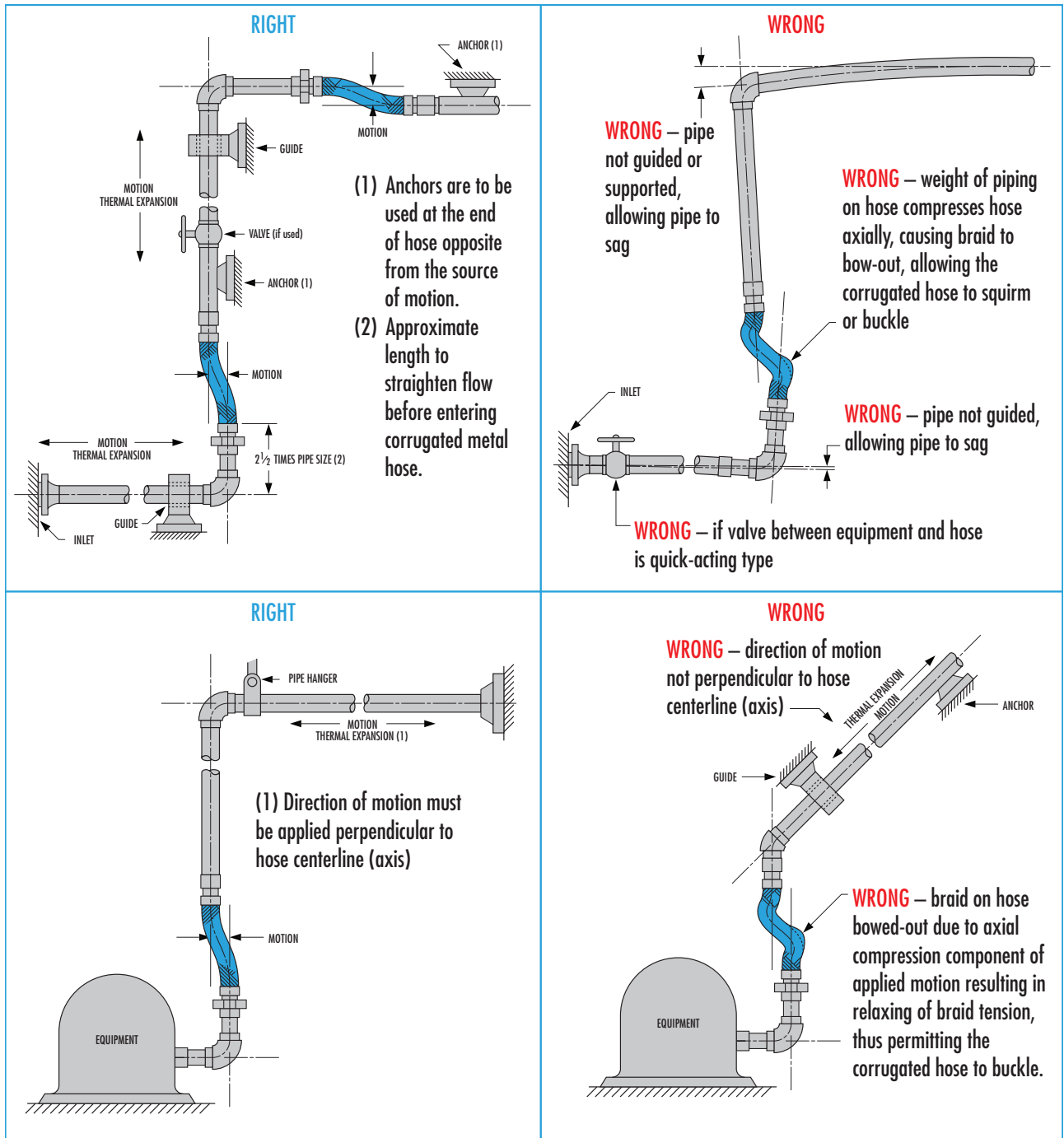

Handling Guide

Hose Storage

- Hoses should be stored in a straight line, raised off the ground on firm level supports or storage racks, preferably in a cool area.
- Ensure hose has been drained and is dry before moving into storage. Place flange covers or caps on threads to prevent ingress of foreign objects or debris into the bore of the hose.

Basic Assembly Handling & Installation

- When handling our products, particularly where end fittings are not fitted, there is a possibility of laceration to the skin due to protruding wires and skin contamination may occur. Care should also be exercised when handling the products if they are coiled up, as injury may occur when removing packaging straps due to the tension in the product being released.
- It is advisable that protective gloves and/or safety glasses should be worn when handling the products.
- Hoses should not be dragged on the floor or along any object that may snag, wear, cut or damage the braid covering in any way.
- Do not stand on, drive over or place objects on the hose that may dent or deform the convolutions in any way.
- Hose is not designed or meant to act as a hanger or support for any other components.
- Always follow industry recommended practices for handling and installing and Hose assemblies and fittings.
 - When tightening tapered threaded ends, such as National Pipe Thread (NTP) fittings, use a quality pipe thread sealing compound or tape and tighten the male fittings 2 to 2½ full turns past the hand tight position. If leakage is observed tighten further in small increments. Over tightening can cause the pipe fitting to deform and damage the components.
 - When tightening couplings, tighten to the recommended torque values as stated by the coupling style. Tighten by bringing the sealing faces together and turning the nut only. Do not allow the sealing surfaces to rotate against one another otherwise they may gall and scratch, preventing a proper seal.
 - When welding pipe ends care must be taken to prevent excessive heat being placed in the fitting to hose weld. Under no circumstances should the fitting to hose weld be re-melted or have any welding performed to it.
- **NEVER** wrench on the hose or the collars of a hose assembly.
- Install hose assembly so there is no live length contact with foreign objects, framing, piping or any other component that could rub against and wear the braid during normal operational vibration.
- Never axially compress a braided metal hose assembly to facilitate installation.

Cleaning

- Hoses should be cleaned after use and certainly before prolonged storage or testing.
- Before commencing any cleaning operation, the user must satisfy himself that the method he proposes to use is safe, and will not result in any dangerous reactions with the chemical residues left in the hose.
- Flushing out is sufficient in many circumstances using a variety of fluids, e.g. clean water, hot water detergents, common solvents at ambient temperature.
- Loose steam or compressed air may be used but the hose must be open ended and the maximum working pressure must not be exceeded.

Oxygen and Cleaned Assemblies

- Should remain bagged or suitably protected until installation.
- Installation should be performed using only lubricants, thread sealing compounds and gaskets specifically designed for oxygen service or are compatible with the application and media.

Inspection Guide

Periodic Inspection of Hose Assemblies

- A hose inspection program can reduce equipment downtime and maintain peak operating performance.
- Inspection should be done on a regular basis with frequency based on prior history of the equipment, a set maintenance program, and the severity of the application.
- Always use appropriate safety considerations when performing inspection of hose assemblies to avoid personal injury. Be aware of the potential hazardous area surrounding the hose assembly.
- Inspected hose and fittings for the following conditions:
 - Broken or corroded wires
 - Physical damage to hose and braid
 - Leakage in the hose or at the end fittings
 - Cracked, damaged, or corroded hose and/or fittings
 - Abrasion along length due to contact with other surfaces
 - If **any** of the above conditions exist, the hose assembly should be replaced immediately.
- If the hose can be removed from the system, additional steps can be taken to ensure a properly maintained assembly. Before performing any inner bore inspection and maintenance, be aware of the possible presence of media left in the hose bore and corrugations, even after cleaning with a compatible cleaning media.
- Inspected hose bore and fittings for the following conditions:
 - Obstructions
 - Physical damage to hose bore
 - Corrosion to hose or fittings

Retesting of Hose Assemblies

- Drain and thoroughly clean hose.
- Carry out visual inspection. Only pressure hoses assemblies which have passed a visual inspection without any of the conditions as stated above.
- Retesting of the hose should be done periodically based on based on the risk potential. Hydrostatic testing should be performed according the maximum test pressure of the hose or 1.5x the working pressure.
- Do to NOT exceed the maximum test pressure of the end fittings that have been used on the hose assembly.
- Consult the factory for any assistance in determining proper test pressures and methods.

Removal from Service

- Any hose which exhibits any of the above characteristics should be removed from service immediately.
- The factory may be consulted to:
 - Review a hose's suitability for service
 - Perform testing to verify integrity and performance
 - Provide repair, if possible
 - Obtain replacement

Reference Data

FRACTIONS AND DECIMAL EQUIVALENTS

$1/64$.015625	$17/64$.265625	$33/64$.515625	$49/64$.765625
$1/32$.03125	$9/32$.28125	$17/32$.53125	$25/32$.78125
$3/64$.046875	$19/64$.296875	$35/64$.546875	$51/64$.796875
$1/16$.0625	$5/16$.3125	$9/16$.5625	$13/16$.8125
$5/64$.078125	$21/64$.328125	$37/64$.578125	$53/64$.828125
$3/32$.09375	$11/32$.34375	$19/32$.59375	$27/32$.84375
$7/64$.109375	$23/64$.359375	$39/64$.609375	$55/64$.859375
$1/8$.125	$3/8$.375	$5/8$.625	$7/8$.875
$9/64$.140625	$25/64$.390625	$41/64$.640625	$57/64$.890625
$5/32$.15625	$13/32$.40625	$21/32$.65625	$29/32$.90625
$11/64$.171875	$27/64$.421875	$43/64$.671875	$59/64$.921875
$3/16$.1875	$7/16$.4375	$11/16$.6875	$15/16$.9375
$13/64$.203125	$29/64$.453125	$45/64$.703125	$61/64$.953125
$7/32$.21875	$15/32$.46875	$23/32$.71875	$31/32$.96875
$15/64$.234375	$31/64$.484375	$47/64$.734375	$63/64$.984375
$1/4$.250	$1/2$.500	$3/4$.750	1	1.0000

CONVERSIONS

Linear

1 Kilometer	= .6214 Mile
1 Meter	= 39.37 Inches
	= 3.2808 Feet
	= 1.0936 Yards
1 Centimeter	= .3937 Inches
1 Millimeter	= .03937 Inches
1 Mile	= 1.609 Kilometer
1 Yard	= .9144 Meter
1 Foot	= 30.48 Centimeter
	= 304.8 Millimeter
1 Inch	= 2.54 Centimeter
	= 25.4 Millimeter

Cubic Measure

1 Cu. meter	= 35.314 Cu. Ft.
	= 1.308 Cu. Yd.
	= 264.2 U.S. Gallons
1 Cu. Centimeter	= .061 Cu. Inch
1 Liter	= 0.0353 Cu. Foot
	= 0.2642 U.S. Gallons
	= 1.0567 U.S. Quart
1 Cu. Yard	= 0.7645 Cu. Meter
1 Cu. Foot	= 0.02832 Cu. Meter
	= 28.317 Liters
1 Cu. Inch	= 16.38716 Cu. Meters
1 U.S. Gallon	= 3.785 Liters
1 U.S. Quart	= 0.946

Pressure

1 Kilogram Per. Sq. Millimeter	= 1422.32 Lb.s Per Sq. Inch
1 Kilogram Per. Sq. Centimeter	= 14.223 Lb.s Per Sq. Inch
1 Kilogram Meter	= 7.233 Foot Lb.s
1 Pound Per Sq. Inch	= 0.0703 Kilogram Per Sq. Centimeter

Temperature

°F	= (1.8 x °C) + 32
°C	= (°F - 32) x 0.555

Square

1 Sq. Kilometer	= .3861 Sq. Mile
1 Sq. Meter	= 10.764 Sq. Ft.
	= 1.196 Sq. Yd.
1 Sq. Centimeter	= .155 Sq. Inch
1 Sq. Millimeter	= 0.00155 Sq. Inch
1 Sq. Mile	= 2.5899 Sq. Kilometer
1 Sq. Yard	= 0.836 Sq. Meter
1 Sq. Foot	= 0.0929 Sq. Meter
	= 929 Sq. Centimeter
1 Sq. Inch	= 6.452 Sq. Centimeter
	= 645.2 Sq. Millimeter

Weight

1 Metric Ton	= 0.9842 Ton (2240 Lb.s)
	= 2204.6 Lb.s
1 Kilograms	= 2.2046 Lb.s
	= .35.274 Oz.s Avoirdupois
1 Gram	= 0.03215 Oz.s Troy
	= 0.03527 Oz.s Avoirdupois
	= 15.432 Grains
1 Ton (2240 Lb.s)	= 1.016 Metric Ton
	= 1016 Kilogram
1 Pound	= 0.4536 Kilogram
	= 453.6 Grams
1 Oz.s Avoirdupois	= 28.35 Grams
1 Oz.s Troy	= 31.013 Grams
1 Grain	= 0.0648 Gram

Metric Abbreviations

Centimeter	= CM
Kilogram	= KG
Kilometer	= KM
Liter	= L
Meter	= M
Millimeter	= MM

Reference Data (continued)

Examples:

A 3" steel pipe line is 138 feet long. Maximum temperature the line will encounter is 440°F. Lowest temperature is 20°F.

Saturated Steam Vacuum In Hg Below 212°F., Pressure psi Gauge Above 212°F.

Calculation:

From the chart — the expansion of steel pipe at:

440°F 3.595 inches per 100 feet of pipe

20°F 0.148 inches per 100 feet of pipe

Difference 3.447 inches per 100 feet of pipe

$\frac{138 \times 3.447}{100} = 4.75"$

or approximately 4¾" total traverse.

A 4" stainless steel line is 50 feet long. Maximum temperature the line will encounter is approximately 580°F. Lowest temperature is approximately — 180°F.

Calculation:

From the chart — the expansion of stainless steel pipe at:

580°F 6.780 inches per 100 feet of pipe

— the contraction of stainless steel pipe at:

—180°F —1.850 inches per 100 feet of pipe

Total Movement 8.630 inches per 100 feet of pipe

$\frac{50 \times 8.630}{100} = 4.315"$

or approximately 4⁵/₁₆" total traverse.

From the "Piping Handbook" by Sabin Crocker, McGraw-Hill Publishing Co.

* Monel is a registered Trademark of International Nickel Co.

* Hastelloy is a registered Trademark of Haynes International

* Inconel is a registered Trademark of the Special Metals Corporation Group of Companies.

Units of Measure stated herein are inches, pounds, fahrenheit and pounds per square inch.

THERMAL EXPANSION OF PIPE										
In Inches Per 100 Feet										
Temperature Degrees Fahrenheit	Cast Iron	Carbon and Carbon Molybdenum Steel	Wrought Iron	4 — 6% Cr Alloy Steel	12% Cr Stainless Steel	18 Cr — 8 Ni Stainless Steel	Copper	Brass	Aluminum 6061 Alloy	Monel Alloy 400
-320					-1.770	-3.110	-2.975		-3.96	-2.60
-300					-1.670	-2.930	-2.805		-3.71	-2.44
-280					-1.570	-2.750	-2.635		-3.46	-2.28
-260					-1.470	-2.570	-2.465		-3.21	-2.12
-240					-1.370	-2.390	-2.295		-2.96	-1.96
-220					-1.270	-2.210	-2.125		-2.71	-1.80
-200	-1.058	-1.282	-1.289	-1.250	-1.170	-2.030	-1.955	-2.065	-2.46	-1.64
-180	0.982	-1.176	-1.183	-1.150	-1.070	-1.850	-1.782	-1.890	-2.22	-1.48
-160	-0.891	-1.066	-1.073	-1.030	-0.970	-1.670	-1.612	-1.705	-1.97	-1.32
-140	-0.797	-0.948	0.955	-0.970	-0.870	-1.480	-1.428	-1.508	-1.73	-1.15
-120	0.697	-0.826	-0.833	-0.800	-0.750	-1.300	-1.235	-1.308	-1.47	-0.98
-100	-0.593	-0.698	-0.705	-0.700	-0.630	-0.900	-1.040	-1.098	-1.22	-0.82
-80	-0.481	-0.563	-0.570	-0.550	-0.520	-0.880	-0.835	-0.888	-0.98	-0.66
-60	-0.368	-0.428	-0.435	-0.430	-0.400	-0.670	-0.630	-0.673	-0.74	-0.49
-40	-0.248	-0.288	-0.295	-0.290	-0.270	-0.450	-0.421	-0.452	-0.49	-0.32
-20	-0.127	-0.145	-0.152	-0.145	-0.130	-0.225	-0.210	-0.227	-0.25	-0.17
0	0.0	0.0	0.0	0.0	0.0	0.0	0.0	0.0	0.0	0.0
20	0.128	0.148	0.180	0.140	0.140	0.223	0.238	0.233	0.34	0.197
32	0.209	0.230	0.280	0.234	0.234	0.356	0.366	0.373	0.54	0.315
40	0.270	0.300	0.350	0.280	0.280	0.446	0.451	0.466	0.68	0.394
60	0.410	0.448	0.540	0.430	0.430	0.669	0.684	0.690	1.01	0.591
80	0.550	0.580	0.710	0.500	0.600	0.892	0.896	0.920	1.35	0.790
100	0.680	0.753	0.887	0.650	0.750	1.115	1.134	1.150	1.69	0.985
120	0.830	0.910	1.058	0.800	0.900	1.338	1.366	1.390	2.02	1.18
140	0.970	1.064	1.240	0.950	1.050	1.545	1.590	1.625	2.36	1.38
160	1.110	1.200	1.420	1.100	1.220	1.784	1.804	1.865	2.68	1.58
180	1.240	1.360	1.580	1.250	1.370	2.000	2.051	2.100	3.03	1.77
200	1.390	1.520	1.750	1.400	1.520	2.230	2.296	2.340	3.38	1.97
212	1.480	1.610	1.870	1.500	1.600	2.361	2.428	2.467	3.59	2.09
220	1.530	1.680	1.940	1.550	1.675	2.460	2.516	2.580	3.72	2.17
240	1.670	1.840	2.120	1.720	1.825	2.680	2.756	2.830	4.05	2.36
260	1.820	2.020	2.300	1.880	2.000	2.920	2.985	3.070	4.39	2.56
280	1.970	2.180	2.470	2.050	2.150	3.150	3.218	3.315	4.72	2.76
300	2.130	2.350	2.670	2.200	2.320	3.390	3.461	3.565	5.07	2.95
320	2.268	2.530	2.850	2.370	2.470	3.615	3.696	3.820	5.41	3.15
340	2.430	2.700	3.040	2.530	2.625	3.840	3.941	4.065	5.74	3.35
360	2.590	2.880	3.230	2.700	2.780	4.100	4.176	4.320	6.08	3.55
380	2.750	3.060	3.425	2.860	2.980	4.346	4.424	4.560	6.42	3.74
400	2.910	3.230	3.620	3.010	3.130	4.580	4.666	4.825	6.77	3.94
420	3.090	3.421	3.820	3.180	3.300	4.800	4.914	5.080	7.10	4.14
440	3.250	3.595	4.020	3.350	3.470	5.050	5.154	5.340	7.44	4.34
460	3.410	3.784	4.200	3.530	3.650	5.300	5.408	5.600	7.77	4.53
480	3.570	3.955	4.400	3.700	3.800	5.540	5.651	5.925	8.11	4.73
500	3.730	4.151	4.600	3.860	4.000	5.800	5.906	6.120	8.44	4.92
520	3.900	4.342	4.810	4.040	4.150	6.050	6.148	6.380	8.78	5.12
540	4.080	4.525	5.020	4.200	4.340	6.280	6.410	6.650	9.13	5.32
560	4.250	4.730	5.220	4.400	4.500	6.520	6.646	6.920	9.46	5.52
580	4.430	4.930	5.430	4.560	4.640	6.780	6.919	7.170	9.80	5.71
600	4.600	5.130	5.620	4.750	4.850	7.020	7.184	7.440	10.14	5.91
620	4.790	5.330	5.840	4.920	5.020	7.270	7.432	7.715	10.49	6.11
640	4.970	5.530	6.050	5.100	5.180	7.520	7.689	7.980	10.82	6.30
660	5.150	5.750	6.250	5.300	5.350	7.770	7.949	8.240		6.50
680	5.330	5.950	6.470	5.480	5.550	8.020	8.196	8.515		6.70
700	5.520	6.160	6.670	5.650	5.700	8.280	8.472	8.780		6.89
720	5.710	6.360	6.880	5.850	5.900	8.520	8.708	9.050		7.09
740	5.900	6.570	7.100	6.030	6.040	8.780	8.999	9.324		7.29
760	6.090	6.790	7.320	6.220	6.280	9.050	9.256	9.600		7.49
780	6.280	7.000	7.530	6.410	6.480	9.300	9.532	9.870		7.68
800	6.470	7.230	7.730	6.610	6.680	9.580	9.788	10.150		7.88
820	6.660	7.450	7.960	6.800	6.890	9.820	10.068	10.425		8.08
840	6.850	7.660	8.180	7.000	7.090	10.100	10.308	10.690		8.28
860	7.049	7.970	8.400	7.190	7.300	10.370	10.610	10.975		8.47
880	7.248	8.100	8.630	7.380	7.500	10.630	10.971	11.250		8.67
900	7.460	8.340	8.870	7.580	7.720	10.900	11.156	11.545		8.86
920	7.668	8.540	9.070	7.770	7.950	11.180	11.421	11.815		9.09
940	7.862	8.770	9.300	7.970	8.140	11.460	11.707	12.120		9.26
960	8.073	8.990	9.520	8.170	8.350	11.730	11.976	12.420		9.46
980	8.300	9.220	9.740	8.360	8.550	12.000	12.269	12.720		9.65
1000	8.510	9.420	9.970	8.550	8.750	12.260	12.543	13.080		9.85
1020		9.650		8.750	12.550					
1040		9.870		8.950	12.820					
1060		10.080		9.150	13.100					
1080		10.320		9.350	13.370					
1100		10.570		9.540	13.620					
1120		10.750		9.750	13.910					
1140		10.980		9.950	14.170					
1160		11.210		10.150	14.450					
1180		11.430		10.360	14.720					
1200		11.630		10.490	14.980					
1220		11.870		10.750	15.260					
1240		12.100		10.950	15.530					
1260		12.330		11.150	15.810					
1280		12.550		11.350	16.080					
1300		12.750		11.550	16.340					
1320		12.980		11.750	16.620					
1340		13.210		11.950	16.900					
1360		13.420		12.150	17.170					
1380		13.650		12.350	17.430					
1400		13.870		12.540	17.700					
1420					17.980					
1440					18.250					
1460					18.520					
1480					18.800					
1500					19.070					

VACUUM INCHES OF HG

PRESSURE PSI GAUGE

29.39
28.89
27.99
26.48
24.04
20.27
14.63
6.45
0
2.5
10.3
20.7
34.5
52.3
74.9
103.3
138.3
180.9
232.4
293.7
366.1
451.3
550.3
664.3
795.3
945.3
1308
1525
1768
2041
2346
2705
3080

Certifications

ISO 9001-2008/2015



AS9100



NADCAP



ISO 10380



Product Certifications

- ISO 10380
- Canadian Registry Numbers (CRN)
- Bureau Veritas® Type Approvals
- American Bureau of Shipping® (ABS) Type Approvals
- EN 13765 & EN 13766
- Pressure Equipment Directive (PED)
- Underwriters Laboratories (UL)
- Factory Mutual (FM)
- Conformité Européenne (CE)

NOTES

UNITED FLEXIBLE

United Flexible, Inc.

815 Forestwood Drive
Romeoville, IL 60446, USA
T: +1 815-886-1140
F: +1 815-886-4550

Global Leader of Flexible Hose and Assemblies

Metal

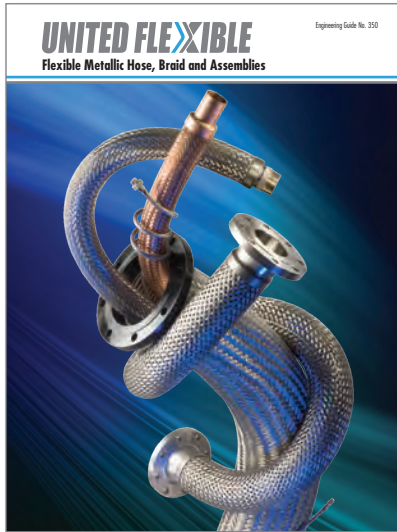

Fluoropolymer



Composite

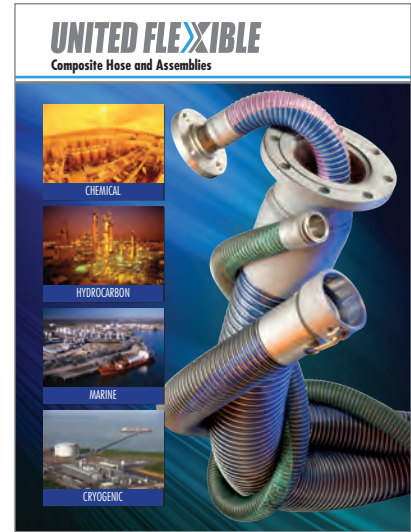

Global Operations and Technical Support Centers

e-mail: info@unitedflexible.com

US Hose Corp.

815 Forestwood Drive
Romeoville, IL 60446, USA
T: +1 815-886-1140
F: +1 815-886-4550

AmniTec Limited

Abercarnaid, Merthyr Tydfil
United Kingdom CF48 1UX
T: +44 (0) 1685-354222
F: +44 (0) 1685-389683

US Hose Corp.

2020 Greens Road, Suite 400
Houston, TX 77032, USA
T: +1 281-458-0400
F: +1 281-458-7809

AmniTec B.V

Abraham van Stolkweg 118
3041 JA Rotterdam, The Netherlands
T: +31 (0) 10 298 2121
F: +31 (0) 10 2982128

Fulton Bellows, LLC

2801 Red Dog Lane
Knoxville, TN 37914
T: +1 865-546-0550
F: +1 865-544-5125

Habia Teknofluor AB

SE-741 80 Knivsta, Sweden
T: 46 (0) 18 34 75 00

www.unitedflexible.com